

EQUAL S

90-2027-N3-M3

Downlight EQUAL S 25.9W 4000K CRI 80 Grey IP54 2370lm

TECHNICAL FEATURES

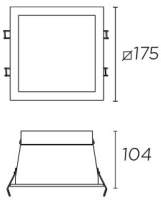

Power (W) : 25.9W

Real lumens : 2370

Real lm/W : 95

Correlated Colour Temperature (CCT) : LED neutral-white 4000K

Structure material : Aluminium

Structure finish : Grey

Diffuser material : Methacrylate

Diffuser finish : Tinted

Equipment necessary but not included :

Voltage / frequency : max. 700mA

Useful life : 50.000h L80B20

Max. temperature : 25°C

Warranty : 2 Years

Energy efficiency : LED A++

LUMINOTECHNIC FEATURES

Light source: LED CREE

CRI: 80

MacAdam steps: 2

Photobiological risk: RG1

VENTILATION FEATURES

Service value measurement standard: EN 60879:2019

LOGISTICS

Net weight (kg): 1.1

Packaged weight (kg): 1.45

Packaging: 210mm x 210mm x 140mm



Luminaire		Measur.		Lamp		
Code	90-2027	Code	90-2027	Code	L2027 25.9W WHITE N	
Name	Downlight EQUAL 25.9W white n	Name	Downlight EQUAL 25.9W white n	Number	1	
Line	Eulumdat	Date	01-12-2014	Position		
Efficiency	100.00%	Coordinate system	CG	Total Flux	2370.06 lm	
Maximum value	1118.21 cd	Position	C=0.00 G=0.00	Double Symmetrical		
Rectangular Luminaire	Length	175 mm	Width	175 mm	Height	3 mm
Rectangular Luminous Area	Length	142 mm	Width	142 mm	Height	0 mm
Horizontal Luminous Area	0.020164 m2	Emitting area on Plane 180°		0.000000 m2		
Emitting area on Plane 0°	0.000000 m2	Emitting area on Plane 270°		0.000000 m2		
Emitting area on Plane 90°	0.000000 m2	Glare area at 76°		0.004878 m2		
Symmetry Type	Double Symmetrical	Maximum Gamma Angle		90		
Measurement Distance	0.00	Measurement Flux		2370.06 lm		
Operator	Asselum T2	Source voltage				
Temperature	25.00 °C	Source current				
Humidity	60.00 %	Photocell				
Notes						

Luminaire Lamps						
Line	Code	Name	Flux [lm]	Pow. [W]	Q.ty	
Eulumdat	L2027 25.9W WHITE N	L2027 25.9W WHITE N - 26.00 W	2370.06	26.00	1	
C.I.E.	62 89 98 100 100	D DIN 5040		A50		
F UTE	1.00 C	B NBN		BZ 3		

175mm x 175mm

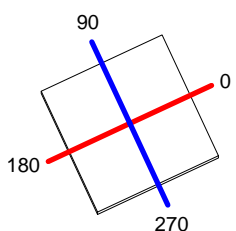

C Halfplanes

180.0 — 0.0

270.0 — 90.0

ULOR 0.00 %

DLOR 100.00 %

RN 0.00 %

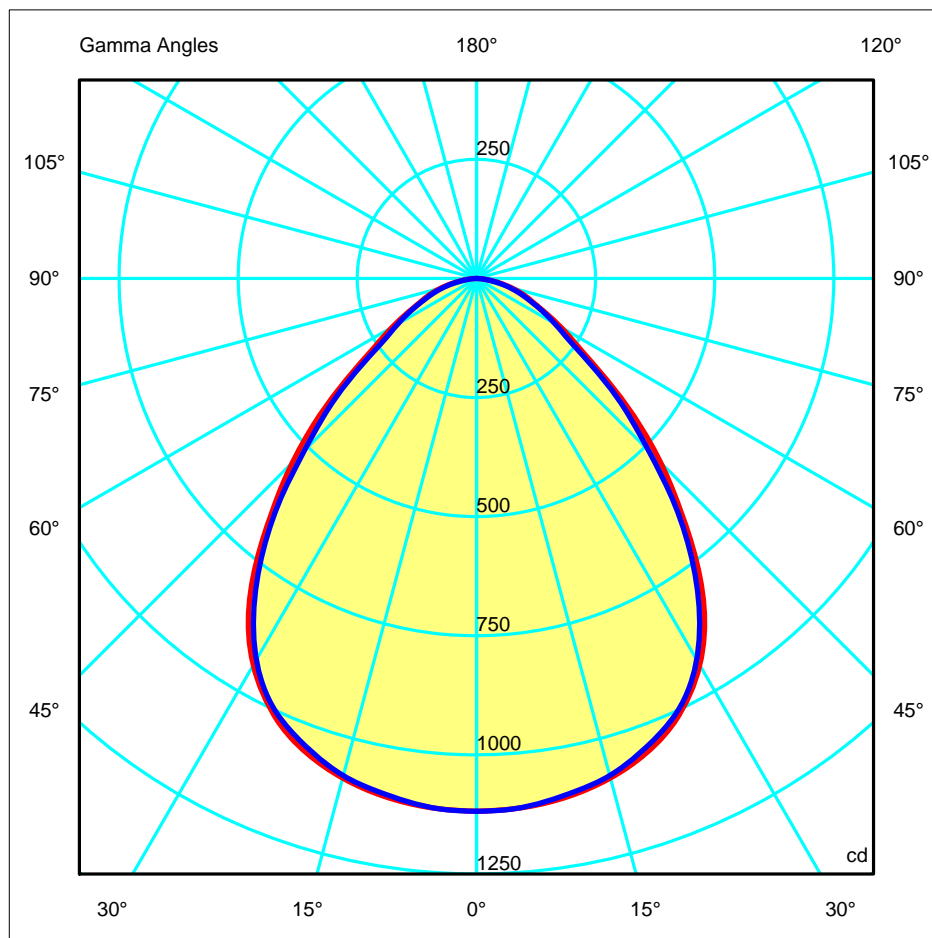

Luminaire		Measur.		Lamp	
Code	90-2027	Code	90-2027	Code	L2027 25.9W WHITE N
Name	Downlight EQUAL 25.9W white n	Name	Downlight EQUAL 25.9W white n	Number	1
Line	Eulmdat	Date	01-12-2014	Position	
Efficiency	100.00%	Coordinate system	CG	Total Flux	2370.06 lm

175mm x 175mm

C Halfplanes

180.0 ————— 0.0
 270.0 ————— 90.0

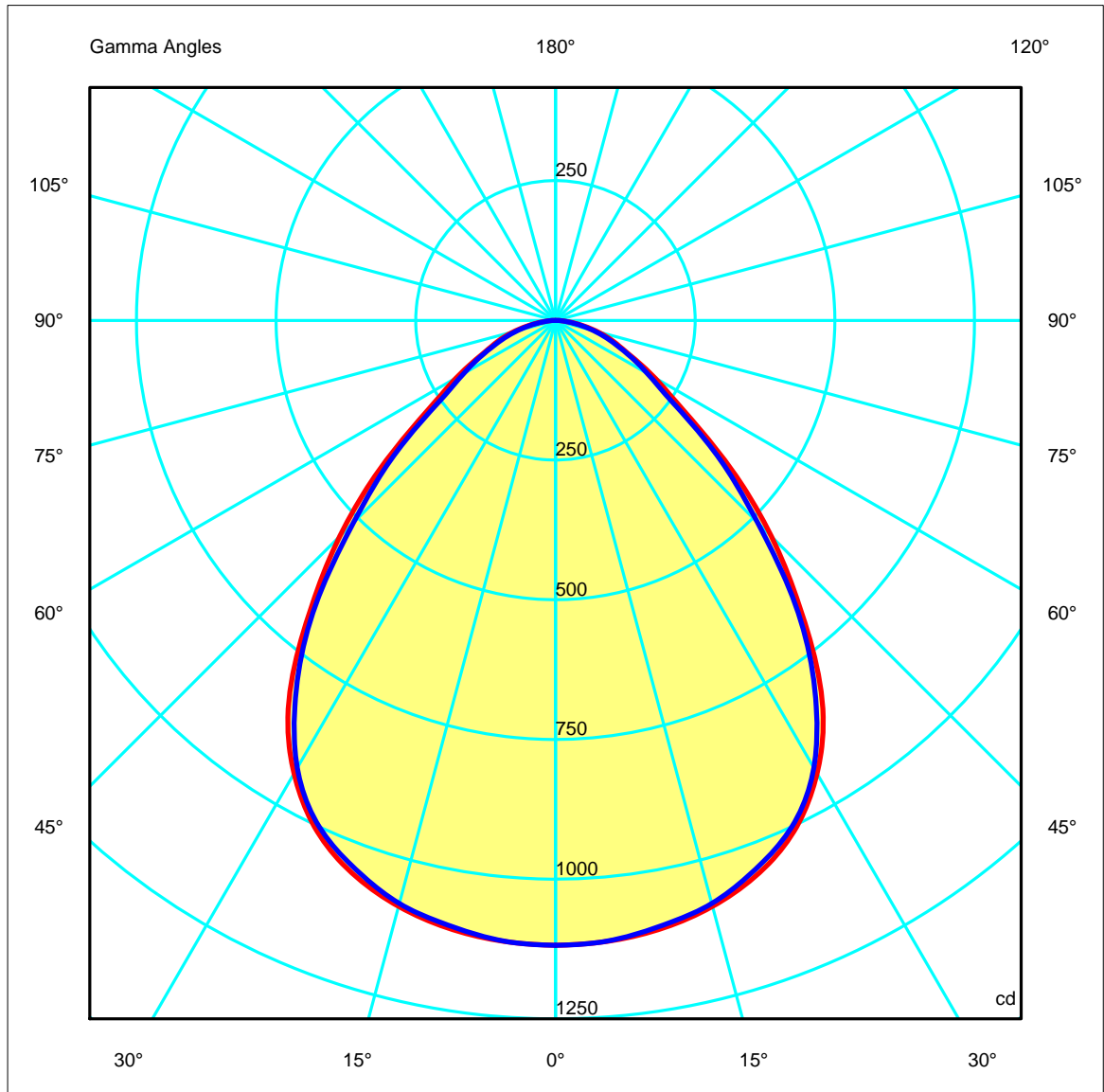
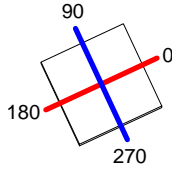

Luminaire		Measur.		Lamp	
Code	90-2027	Code	90-2027	Code	L2027 25.9W WHITE N
Name	Downlight EQUAL 25.9W white n	Name	Downlight EQUAL 25.9W white n	Number	1
Line	Eulumdat	Date	01-12-2014	Position	
Efficiency	100.00%	Coordinate system	CG	Total Flux	2370.06 lm

Width at 50.00 % of Max Intensity

H[m]	1.00	2.00	3.00	4.00	5.00	H[m]	1.00	2.00	3.00	4.00	5.00
OA	0.98	1.97	2.95	3.94	4.92	OC	0.95	1.89	2.84	3.79	4.73
OB	0.98	1.97	2.95	3.94	4.92	OD	0.95	1.89	2.84	3.79	4.73

	Luminous Intensities [cd]									
	0	5	15	25	35	45	55	65	75	85
OA	1118.21	1114.79	1085.54	1009.29	832.40	546.25	277.75	146.79	77.60	20.01
OB	1118.21	1114.79	1085.54	1009.29	832.40	546.25	277.75	146.79	77.60	20.01
OC	1118.21	1114.20	1080.11	1000.26	809.42	510.86	255.93	141.96	71.22	15.85
OD	1118.21	1114.20	1080.11	1000.26	809.42	510.86	255.93	141.96	71.22	15.85

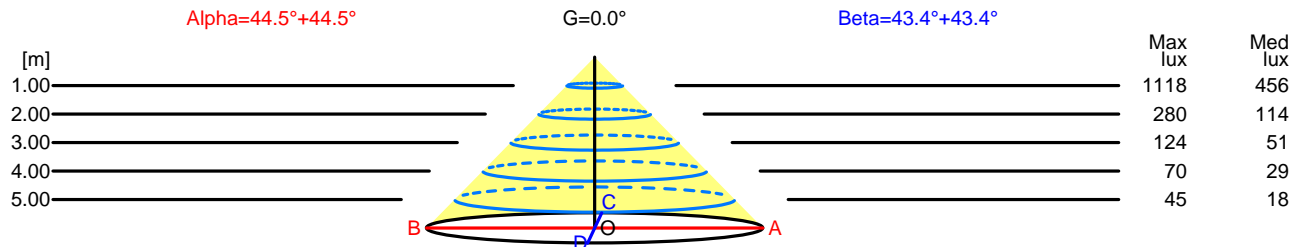

H[m]	D[m]	Max lux	Med lux	Alpha=44.5°+44.5°	G=0.0
1.00	1.97	1118	456		
2.00	3.94	280	114		
3.00	5.90	124	51		
4.00	7.87	70	29		
5.00	9.84	45	18		

H[m]	D[m]	Max lux	Med lux	Beta=43.4°+43.4°	G=0.0
1.00	1.89	1118	456		
2.00	3.79	280	114		
3.00	5.68	124	51		
4.00	7.58	70	29		
5.00	9.47	45	18		

Luminaire		Measur.		Lamp	
Code	90-2027	Code	90-2027	Code	L2027 25.9W WHITE N
Name	Downlight EQUAL 25.9W white n	Name	Downlight EQUAL 25.9W white n	Number	1
Line	Eulumdat	Date	01-12-2014	Position	
Efficiency	100.00%	Coordinate system	CG	Total Flux	2370.06 lm

Isolux (Floor)

Luminaire position X=0.00m Y=0.00m Z=3.00m

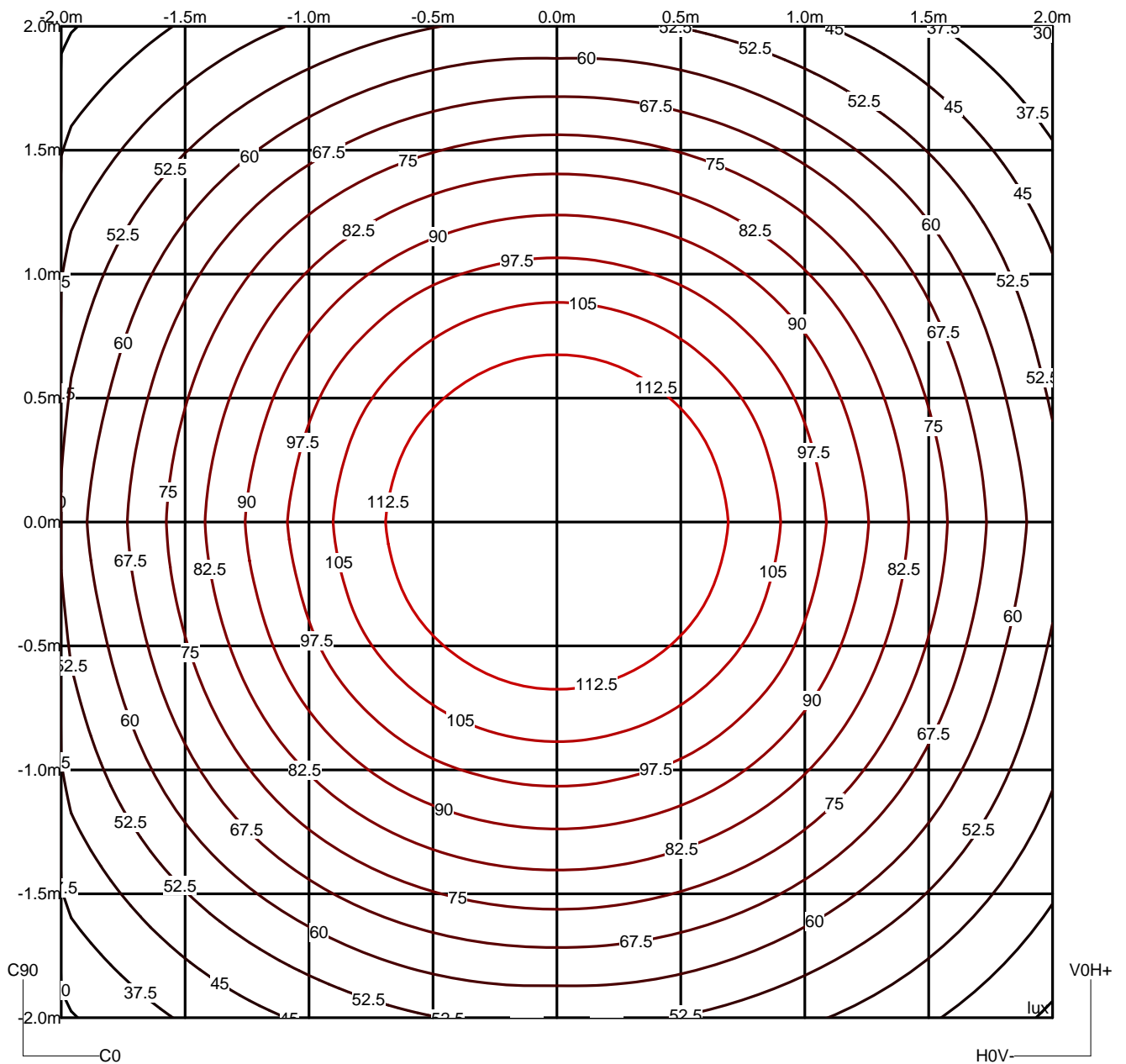

Luminaire

Code 90-2027
 Name Downlight EQUAL 25.9W white n
 Line Eulumdat

Measur.

Code 90-2027
 Name Downlight EQUAL 25.9W white n
 Date 01-12-2014

Lamp

Code L2027 25.9W WHITE N
 Number 1
 Position

Efficiency 100.00% Coordinate system CG Total Flux 2370.06 lm

		Average Luminance [cd/m ²]										
		0.0°	45°	50°	55°	60°	65°	70°	75°	80°	85°	
0.0°		38312	31254	24015	20310	17225	16015	14868	12392	11388	---	
90.0°		35829	29347	22129	18867	16658	14898	13646	10923	9017	---	

Flush mounted or longitudinal view												
		Illumination(lx)										
A	A	2000	1000	750	500		<300					1.15
B	1		2000	1500	1000	750	500	<300				1.5
C					2000		1000	500	<300			1.85
D	2						2000	1000	500	<300		2.2
E	3							2000	1000	500	<300	2.55

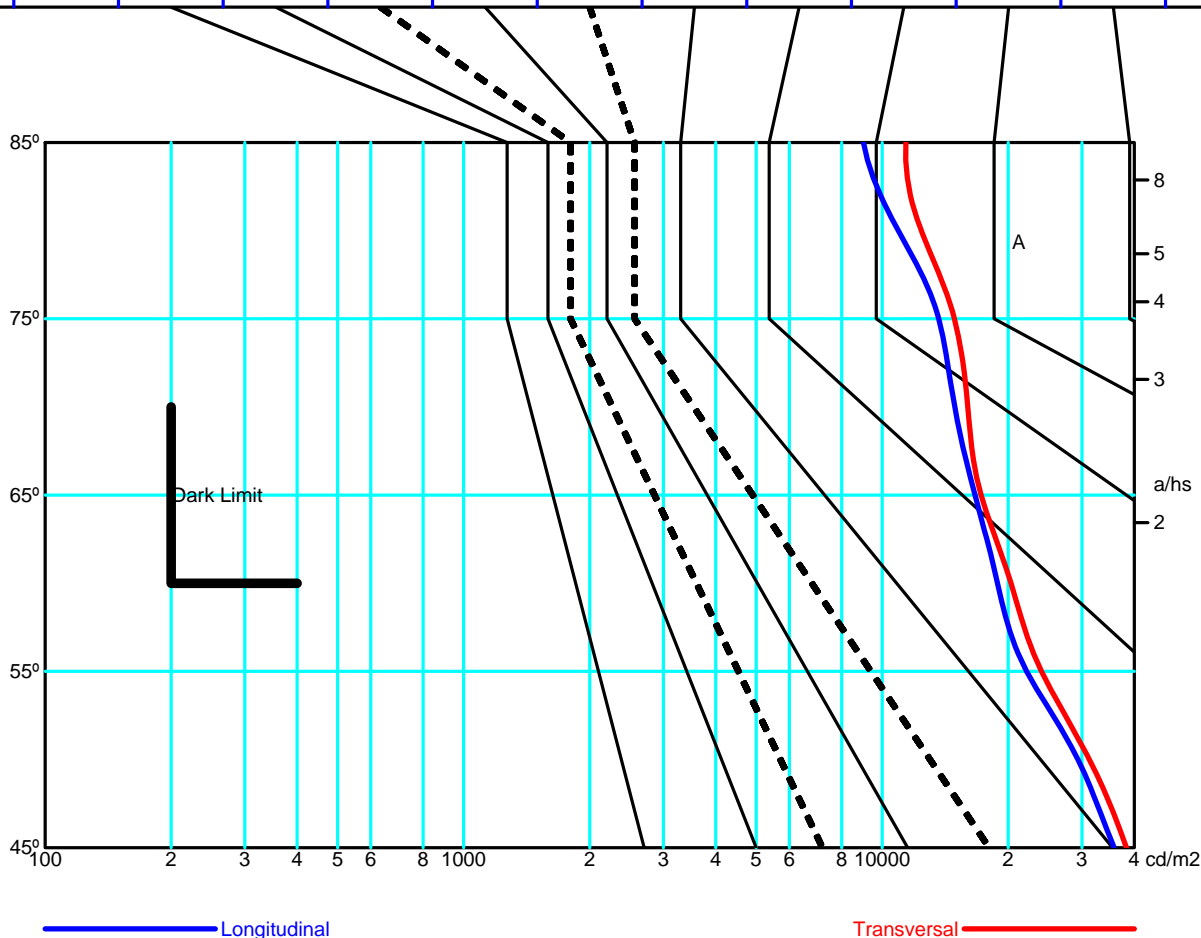

Luminaire		Measur.		Lamp	
Code	90-2027	Code	90-2027	Code	L2027 25.9W WHITE N
Name	Downlight EQUAL 25.9W white n	Name	Downlight EQUAL 25.9W white n	Number	1
Line	Eulumdat	Date	01-12-2014	Position	
Efficiency	100.00%	Coordinate system	CG	Total Flux	2370.06 lm

175mm x 175mm

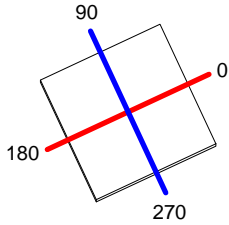

C Halfplanes

180.0 ———— 0.0
 270.0 ———— 90.0

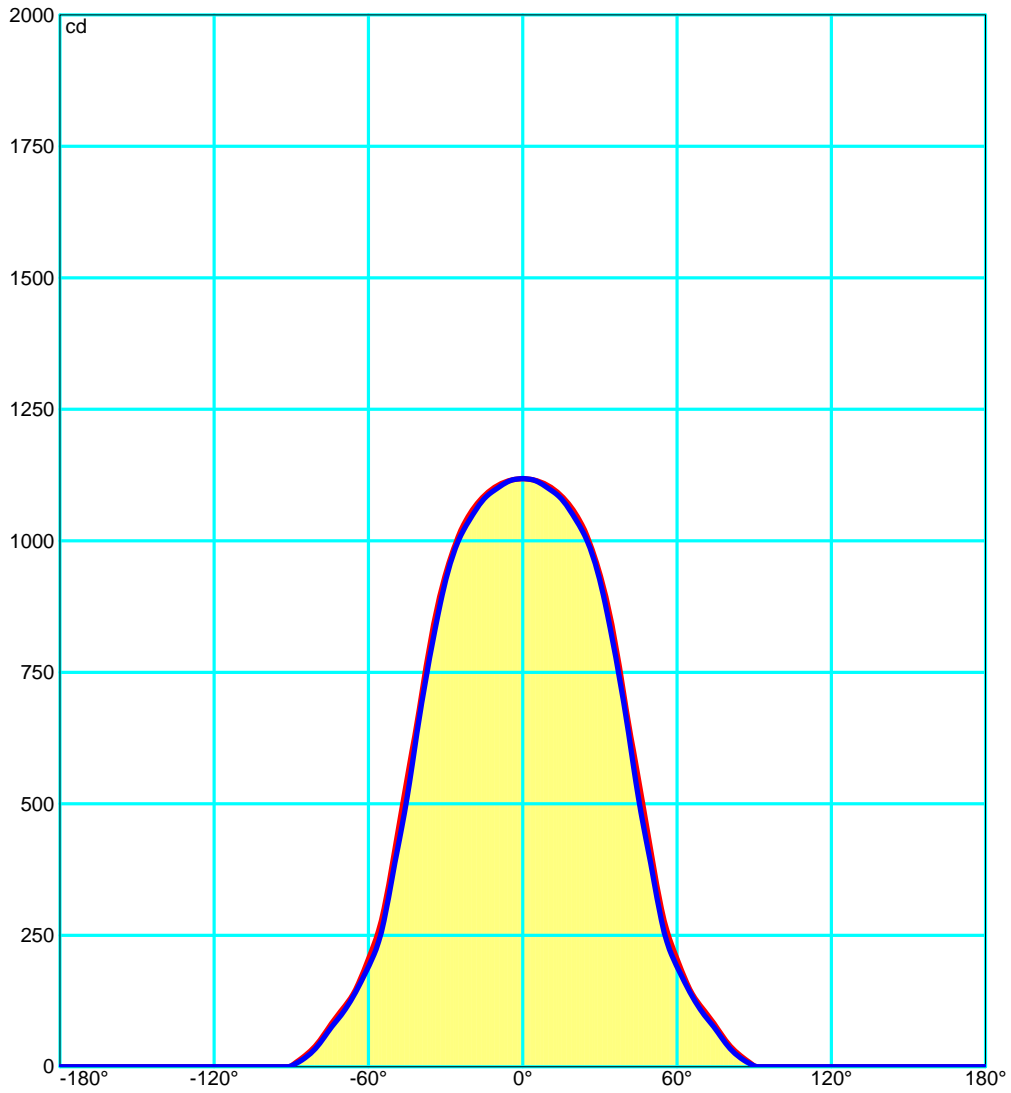

Luminaire		Measur.		Lamp	
Code	90-2027	Code	90-2027	Code	L2027 25.9W WHITE N
Name	Downlight EQUAL 25.9W white n	Name	Downlight EQUAL 25.9W white n	Number	1
Line	Eulumdat	Date	01-12-2014	Position	
Efficiency	100.00%	Coordinate system	CG	Total Flux	2370.06 lm

UGR
S = 0.250

Reflectancies										
Ceiling/Cavity	0.7	0.7	0.5	0.5	0.3	0.7	0.7	0.5	0.5	0.3
Walls	0.5	0.3	0.5	0.3	0.3	0.5	0.3	0.5	0.3	0.3
WorkingPlane	0.2	0.2	0.2	0.2	0.2	0.2	0.2	0.2	0.2	0.2
RoomDimensions	ViewedCrosswise					ViewedEndwise				
x=2H y=2H	23.1	24.2	23.4	24.4	24.7	23.1	24.2	23.4	24.4	24.7
x=2H y=3H	23.8	24.8	24.1	25.0	25.3	23.8	24.8	24.1	25.0	25.3
x=2H y=4H	24.1	25.1	24.4	25.3	25.6	24.1	25.0	24.4	25.3	25.6
x=2H y=6H	24.3	25.2	24.7	25.5	25.7	24.3	25.1	24.6	25.4	25.7
x=2H y=8H	24.4	25.2	24.7	25.5	25.8	24.3	25.2	24.7	25.5	25.8
x=2H y=12H	24.4	25.2	24.8	25.5	25.8	24.3	25.1	24.7	25.5	25.8
x=4H y=2H	23.6	24.6	24.0	24.9	25.1	23.6	24.6	24.0	24.8	25.1
x=4H y=3H	24.5	25.3	24.8	25.6	25.9	24.5	25.3	24.8	25.6	25.9
x=4H y=4H	24.9	25.6	25.3	25.9	26.3	24.9	25.6	25.3	25.9	26.3
x=4H y=6H	25.2	25.8	25.6	26.2	26.5	25.1	25.7	25.6	26.1	26.5
x=4H y=8H	25.3	25.8	25.7	26.2	26.6	25.2	25.8	25.7	26.2	26.6
x=4H y=12H	25.4	25.9	25.8	26.3	26.6	25.3	25.8	25.7	26.2	26.6
x=8H y=4H	25.1	25.6	25.5	26.0	26.4	25.0	25.6	25.5	26.0	26.4
x=8H y=6H	25.4	25.9	25.9	26.3	26.7	25.4	25.9	25.9	26.3	26.7
x=8H y=8H	25.6	26.0	26.1	26.4	26.9	25.6	26.0	26.0	26.4	26.9
x=8H y=12H	25.7	26.0	26.2	26.5	27.0	25.6	26.0	26.1	26.5	27.0
x=12H y=4H	25.1	25.6	25.5	26.0	26.4	25.0	25.5	25.5	26.0	26.4
x=12H y=6H	25.5	25.9	25.9	26.3	26.8	25.4	25.8	25.9	26.3	26.8
x=12H y=8H	25.6	26.0	26.1	26.4	26.9	25.6	25.9	26.1	26.4	26.9

Luminaire	Measur.	Lamp
Code 90-2027	Code 90-2027	Code L2027 25.9W WHITE N
Name Downlight EQUAL 25.9W white n	Name Downlight EQUAL 25.9W white n	Number 1
Line Eulumdat	Date 01-12-2014	Position

Efficiency 100.00%	Coordinate system CG	Total Flux 2370.06 lm
--------------------	----------------------	-----------------------

Total Flux=2370.06 Luminaire Flux=2370.06

	0.60	0.80	1.00	1.25	1.50	2.00	2.50	3.00	4.00	5.00	10.00	20.00
RI	0.41	0.50	0.57	0.64	0.69	0.76	0.81	0.85	0.88	0.90	0.95	0.97
DRR	3	3	3	3	3	3	3	3	3	3	2	2
RC												

Zonal Flux per 1000 Lumen

	10	20	30	40	50	60	70	80	90	100	110	120	130	140	150	160	170	180
Y°	45	173	368	588	773	892	959	991	1000	1000	1000	1000	1000	1000	1000	1000	1000	1000
ZF(Y)																		

CIE Flux Codes
62 89 98 100 100

C.I.E.	3/3/3/3/3/3/3/3/2/2	LOR	99.99987 %
D DIN 5040	A50	ULOR	0.00000 %
F UTE	1.00 C	DLOR	99.99987 %
B NBN	BZ 3	UFF	0.00000 %
RN	0.00000 %	DFF	100.00000 %
BLF	1.0	FFR	0.00000 %

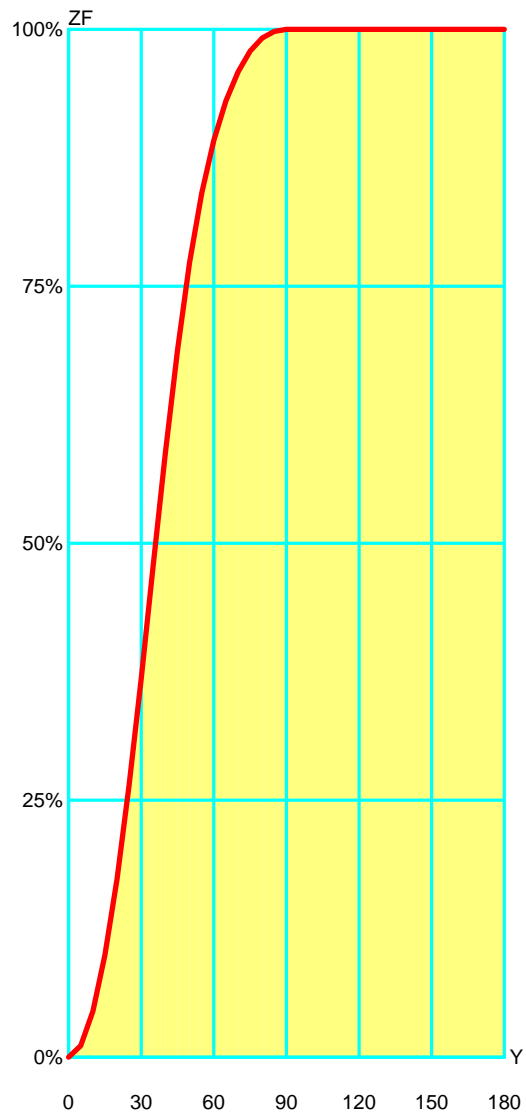

Zonal Flux				
Gamma °	Flux	Sum lm	Flux [%]	Sum [%]
0°	0.00	0.00	0.00%	0.00 %
5°	11.26	11.26	1.13 %	1.13 %
10°	33.43	44.69	3.34 %	4.47 %
15°	54.62	99.31	5.46 %	9.93 %
20°	74.15	173.46	7.42 %	17.35 %
25°	91.06	264.52	9.11 %	26.45 %
30°	103.93	368.45	10.39 %	36.84 %
35°	110.54	478.98	11.05 %	47.90 %
40°	109.30	588.28	10.93 %	58.83 %
45°	99.98	688.26	10.00 %	68.83 %
50°	85.03	773.29	8.50 %	77.33 %
55°	67.40	840.69	6.74 %	84.07 %
60°	51.12	891.81	5.11 %	89.18 %
65°	38.52	930.32	3.85 %	93.03 %
70°	28.25	958.58	2.83 %	95.86 %
75°	20.14	978.72	2.01 %	97.87 %
80°	12.74	991.46	1.27 %	99.15 %
85°	6.42	997.88	0.64 %	99.79 %
90°	2.11	1000.00	0.21 %	100.00 %
95°	0.00	1000.00	0.00 %	100.00 %
100°	0.00	1000.00	0.00 %	100.00 %
105°	0.00	1000.00	0.00 %	100.00 %
110°	0.00	1000.00	0.00 %	100.00 %
115°	0.00	1000.00	0.00 %	100.00 %
120°	0.00	1000.00	0.00 %	100.00 %
125°	0.00	1000.00	0.00 %	100.00 %
130°	0.00	1000.00	0.00 %	100.00 %
135°	0.00	1000.00	0.00 %	100.00 %
140°	0.00	1000.00	0.00 %	100.00 %
145°	0.00	1000.00	0.00 %	100.00 %
150°	0.00	1000.00	0.00 %	100.00 %
155°	0.00	1000.00	0.00 %	100.00 %
160°	0.00	1000.00	0.00 %	100.00 %
165°	0.00	1000.00	0.00 %	100.00 %
170°	0.00	1000.00	0.00 %	100.00 %
175°	0.00	1000.00	0.00 %	100.00 %
180°	0.00	1000.00	0.00 %	100.00 %

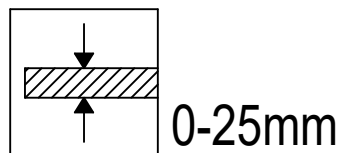
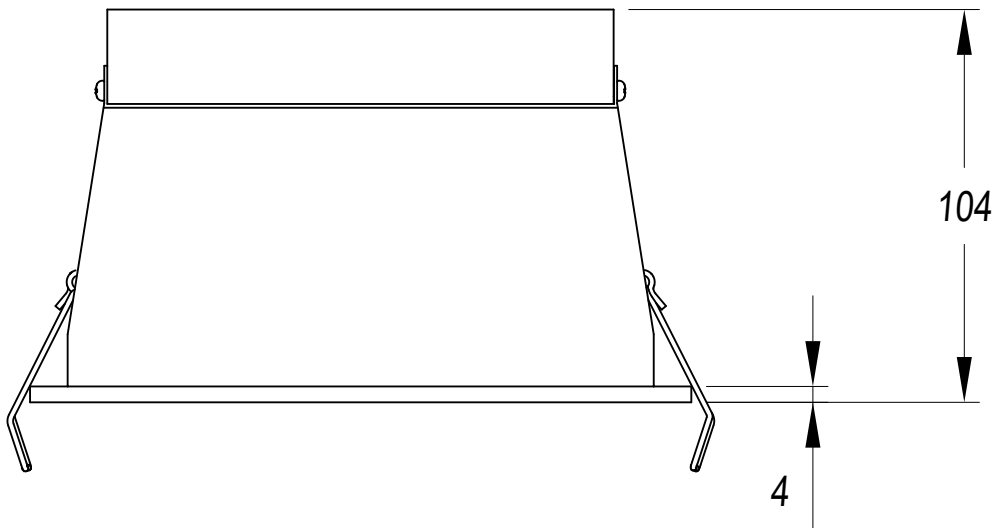
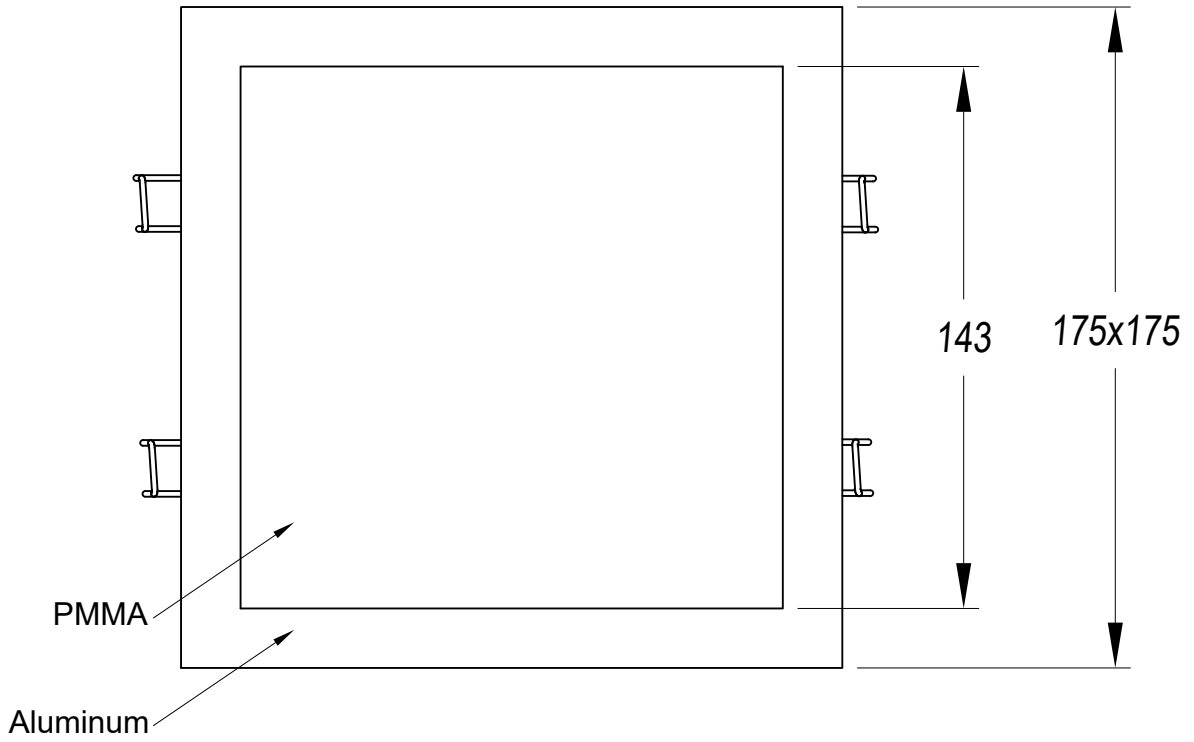

1

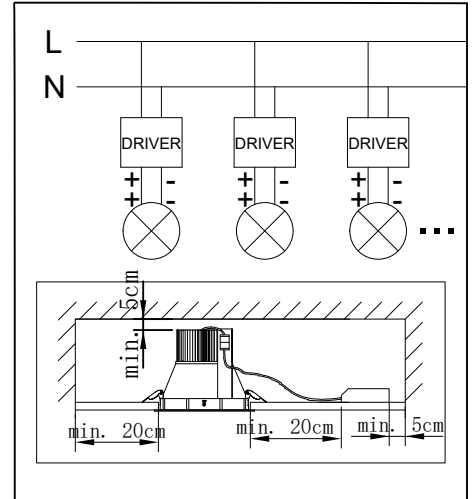
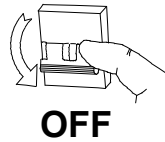
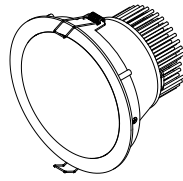
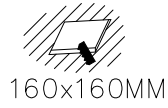
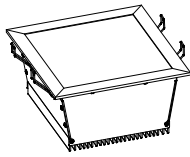

2

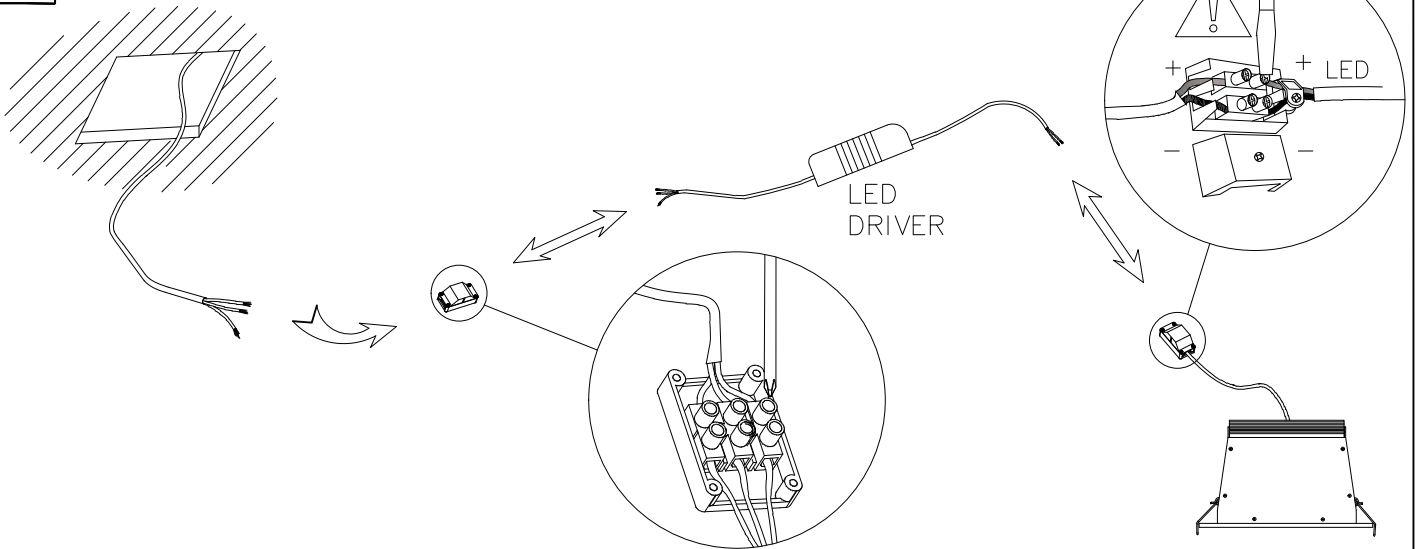

3

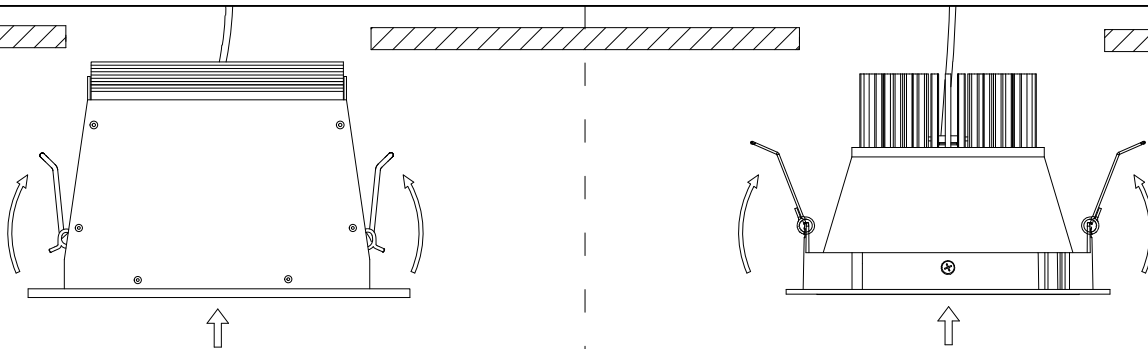

4

