

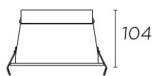
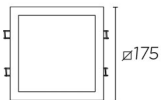

EQUAL S Downlight

**Description**

Downlight EQUAL S 25.9W 3000K CRI 80 Grey IP54 2370lm

	Finish	Material
Structure	Grey	Aluminium
Diffuser	Tinted	Methacrylate

 160x160

 0-25
**TECHNICAL CHARACTERISTICS****Light source**

Light source: LED CREE
 Light source power (W): 25.9W
 Color temperature: LED warm-white
 3000K
 CRI: 80
 Photobiological risk: RG1
 Real Lumen: 2370
 Qty Leds: 1
 Lm/Real W: 95
 Life Time: 50.000h L80B20
 Bin / Grup: 30H
 MacAdam steps: 2
 UGR: 23.1

GEAR

This item requires gear. It is not included.
 Voltage / Frequency: max. 700mA

Luminaire

Warranty: 2 Years

Logistics

Energy Efficiency: LED A++
 EAN Code: 8435381423131
 Net Weight (Kg): 1.1
 Weight in Kg (packaged): 1.45
 Packing: 210 x 210 x 140
 Masterbox: 12

Luminaire		Measur.		Lamp		
Code	90-2026	Code	90-2027	Code	L2026 25.9W 80 3000K	
Name	EQUAL S 25.9W 830 175x175mm	Name	EQUAL S 25.9W 830 175x175mm	Number	1	
Line	Eulumdat	Date	01-12-2014	Position		
Efficiency	100.00%	Coordinate system	CG	Total Flux	2370.06 lm	
Maximum value	1118.21 cd	Position	C=0.00 G=0.00	Double Symmetrical		
Rectangular Luminaire	Length	175 mm	Width	175 mm	Height	3 mm
Rectangular Luminous Area	Length	142 mm	Width	142 mm	Height	0 mm
Horizontal Luminous Area	0.020164 m2	Emitting area on Plane 180°		0.000000 m2		
Emitting area on Plane 0°	0.000000 m2	Emitting area on Plane 270°		0.000000 m2		
Emitting area on Plane 90°	0.000000 m2	Glare area at 76°		0.004878 m2		
Symmetry Type	Double Symmetrical	Maximum Gamma Angle	90			
Measurement Distance	0.00	Measurement Flux	2370.06 lm			
Operator	Asselum T2	Source voltage				
Temperature	25.00 °C	Source current				
Humidity	60.00 %	Photocell				
Notes						

Luminaire Lamps					
Line	Code	Name	Flux [lm]	Pow. [W]	Q.ty
Eulumdat	L2026 25.9W 80 3000K	L2026 25.9W 80 3000K - 26.00 W	2370.06	26.00	1
C.I.E.	62 89 98 100 100	D DIN 5040	A50		
F UTE	1.00 C	B NBN	BZ 3		

175mm x 175mm

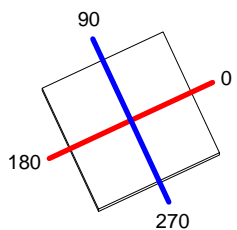

C Halfplanes

180.0 — 0.0

270.0 — 90.0

ULOR 0.00 %

DLOR 100.00 %

RN 0.00 %

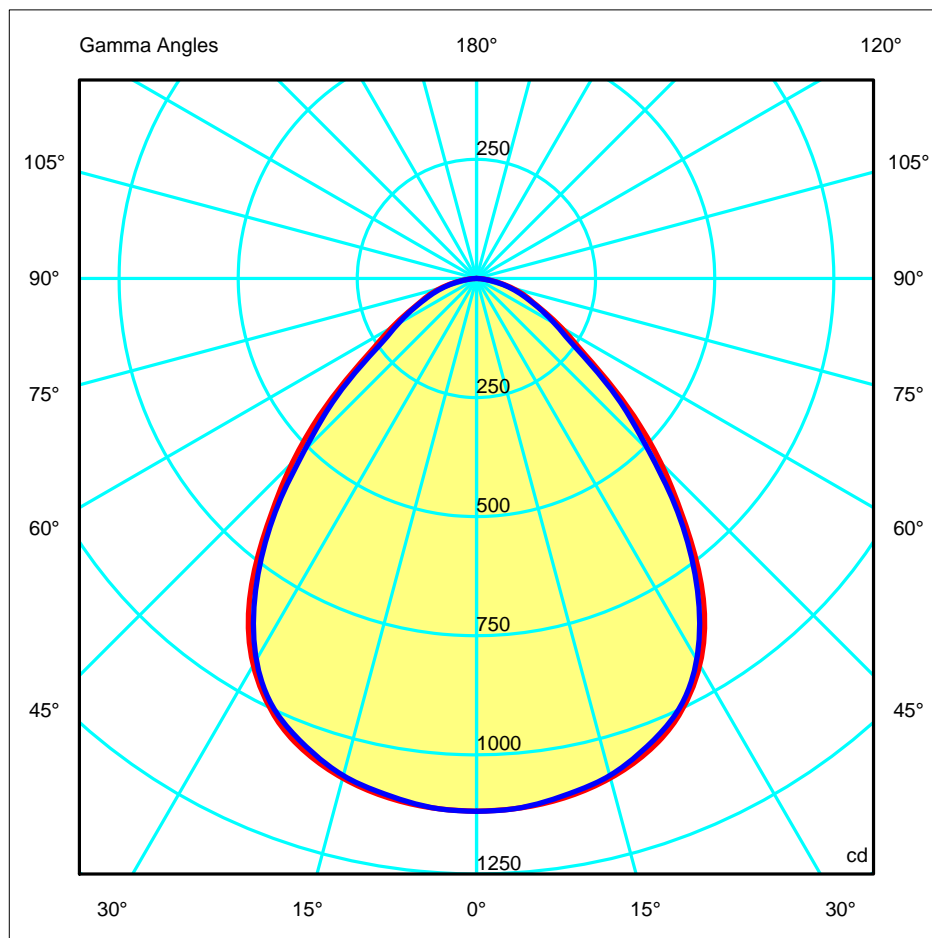

Luminaire		Measur.		Lamp	
Code	90-2026	Code	90-2027	Code	L2026 25.9W 80 3000K
Name	EQUAL S 25.9W 830 175x175mm	Name	EQUAL S 25.9W 830 175x175mm	Number	1
Line	Eulmdat	Date	01-12-2014	Position	
Efficiency	100.00%	Coordinate system	CG	Total Flux	2370.06 lm

175mm x 175mm

C Halfplanes

180.0 ——— 0.0
 270.0 ——— 90.0

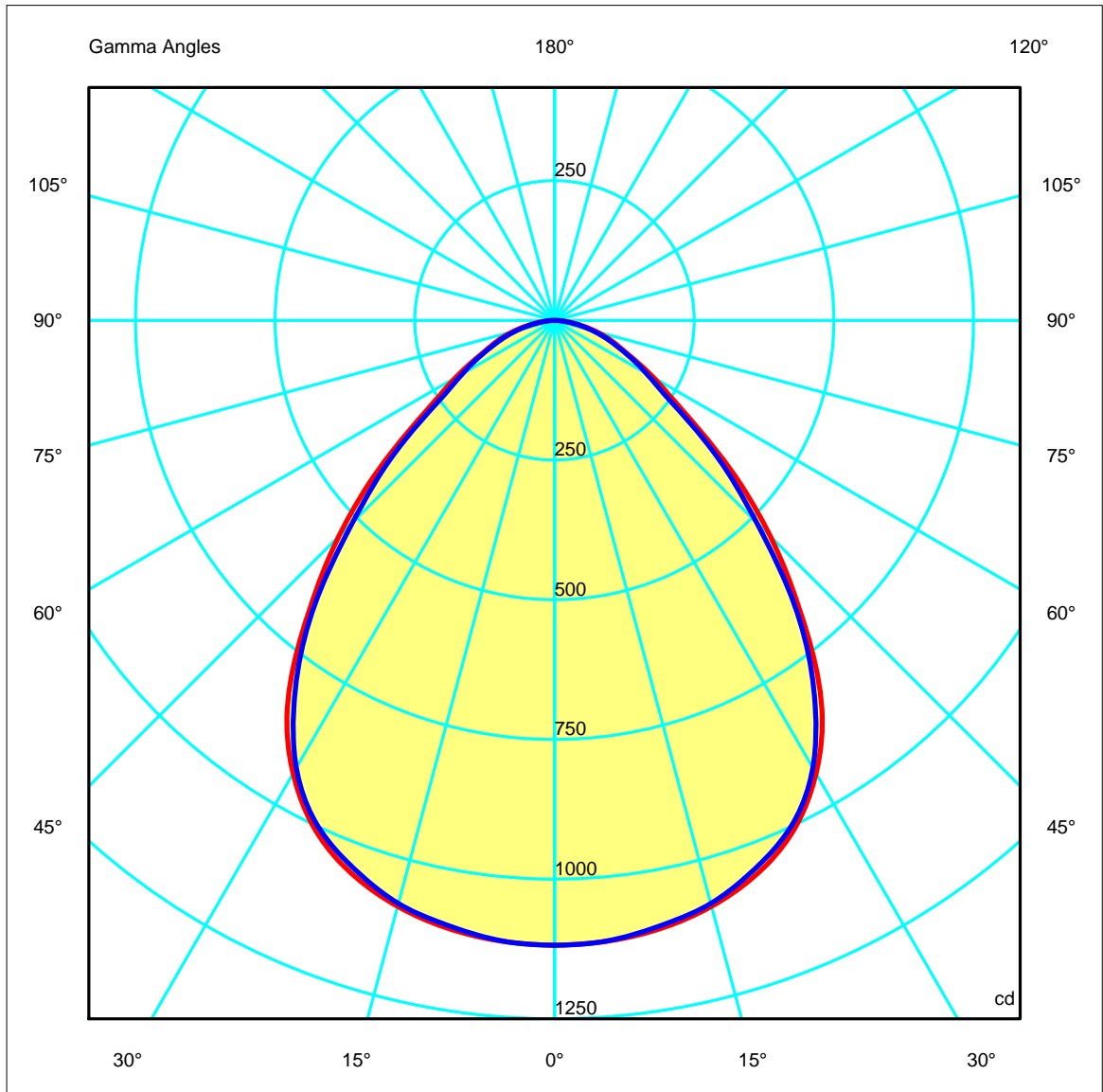
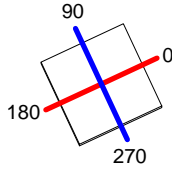

Luminaire	Measur.	Lamp
Code 90-2026	Code 90-2027	Code L2026 25.9W 80 3000K
Name EQUAL S 25.9W 830 175x175mm	Name EQUAL S 25.9W 830 175x175mm	Number 1
Line Eulumdat	Date 01-12-2014	Position

Efficiency	100.00%	Coordinate system	CG	Total Flux	2370.06 lm
------------	---------	-------------------	----	------------	------------

Width at 50.00 % of Max Intensity

	H[m]	1.00	2.00	3.00	4.00	5.00		H[m]	1.00	2.00	3.00	4.00	5.00
	OA	0.98	1.97	2.95	3.94	4.92		OC	0.95	1.89	2.84	3.79	4.73
	OB	0.98	1.97	2.95	3.94	4.92		OD	0.95	1.89	2.84	3.79	4.73

		Luminous Intensities [cd]									
		0	5	15	25	35	45	55	65	75	85
OA		1118.21	1114.79	1085.54	1009.29	832.40	546.25	277.75	146.79	77.60	20.01
OB		1118.21	1114.79	1085.54	1009.29	832.40	546.25	277.75	146.79	77.60	20.01
OC		1118.21	1114.20	1080.11	1000.26	809.42	510.86	255.93	141.96	71.22	15.85
OD		1118.21	1114.20	1080.11	1000.26	809.42	510.86	255.93	141.96	71.22	15.85

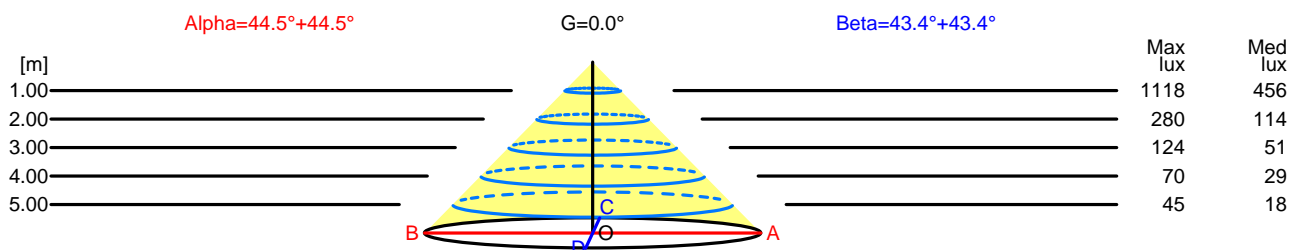

H[m]	D[m]	Max lux	Med lux	Alpha=44.5°+44.5°	G=0.0	
1.00	1.97	1118	456			
2.00	3.94	280	114			
3.00	5.90	124	51			
4.00	7.87	70	29			
5.00	9.84	45	18			

H[m]	D[m]	Max lux	Med lux	Beta=43.4°+43.4°	G=0.0	
1.00	1.89	1118	456			
2.00	3.79	280	114			
3.00	5.68	124	51			
4.00	7.58	70	29			
5.00	9.47	45	18			

Luminaire		Measuram.		Lamp	
Code	90-2026	Code	90-2027	Code	L2026 25.9W 80 3000K
Name	EQUAL S 25.9W 830 175x175mm	Name	EQUAL S 25.9W 830 175x175mm	Number	1
Line	Eulumdat	Date	01-12-2014	Position	
Efficiency	100.00%	Coordinate system	CG	Total Flux	2370.06 lm

Isolux (Floor)

Luminaire position X=0.00m Y=0.00m Z=3.00m

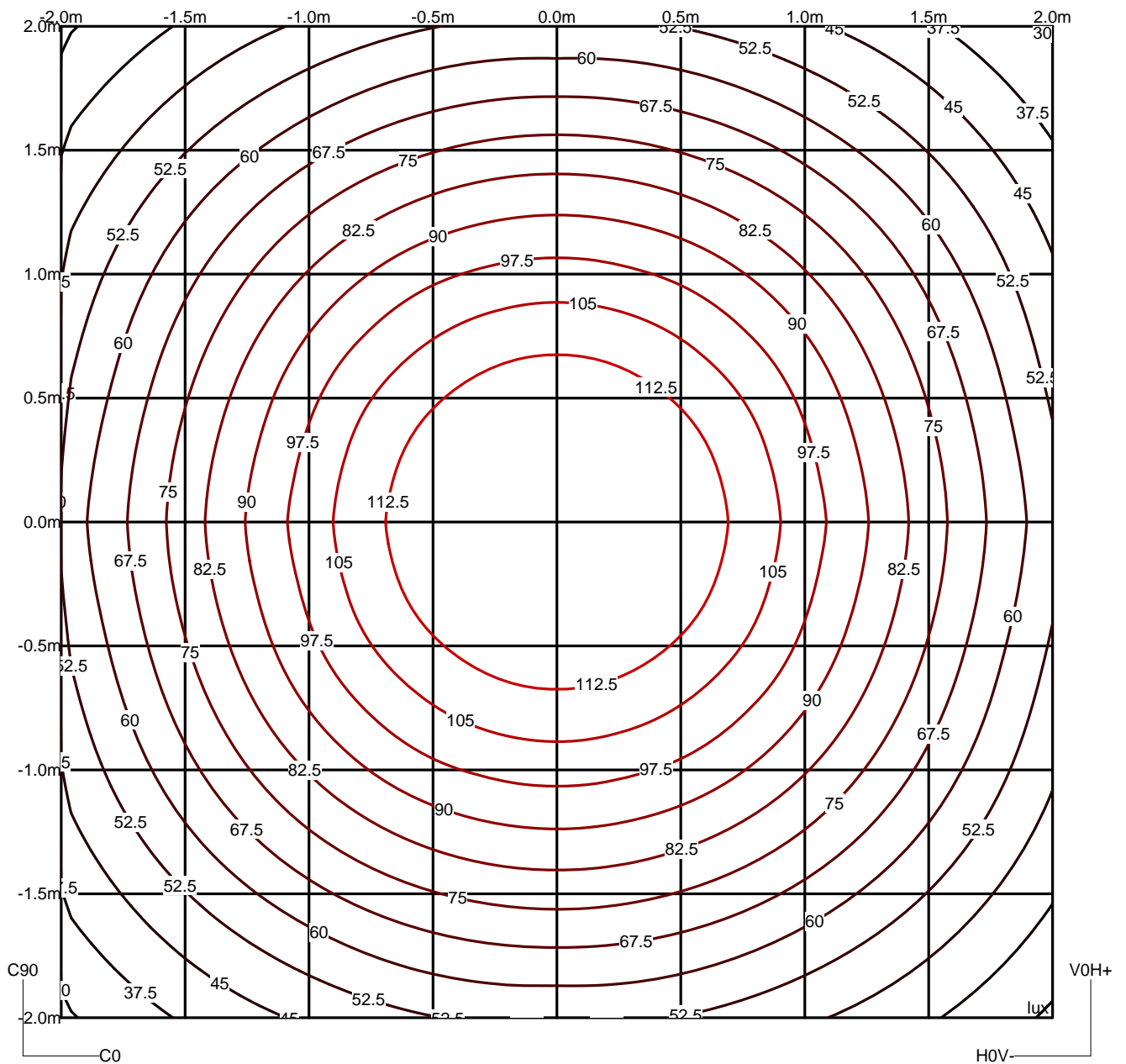

Luminaire

Code 90-2026
 Name EQUAL S 25.9W 830 175x175mm
 Line Eulumdat

Measur.

Code 90-2027
 Name EQUAL S 25.9W 830 175x175mm
 Date 01-12-2014

Lamp

Code L2026 25.9W 80 3000K
 Number 1
 Position

Efficiency 100.00% Coordinate system CG Total Flux 2370.06 lm

		Average Luminance [cd/m ²]									
		45°	50°	55°	60°	65°	70°	75°	80°	85°	
0.0°		38312	31254	24015	20310	17225	16015	14868	12392	11388	---
90.0°		35829	29347	22129	18867	16658	14898	13646	10923	9017	---

Flush mounted or longitudinal view												
		Illumination(lx)										
A	A	2000	1000	750	500		<300					1.15
B	1		2000	1500	1000	750	500	<300				1.5
C					2000		1000	500	<300			1.85
D	2						2000	1000	500	<300		2.2
E	3							2000	1000	500	<300	2.55

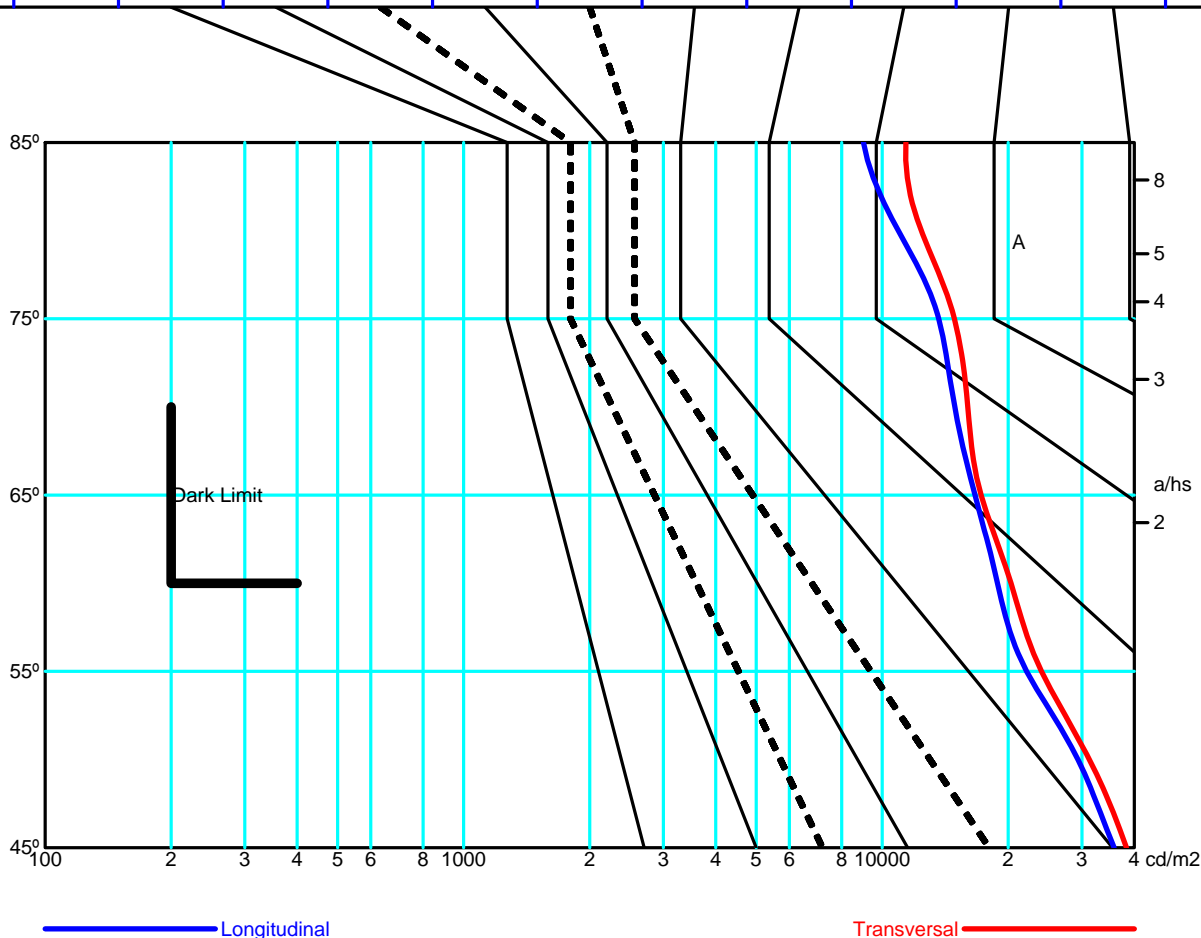

Luminaire		Measur.		Lamp	
Code	90-2026	Code	90-2027	Code	L2026 25.9W 80 3000K
Name	EQUAL S 25.9W 830 175x175mm	Name	EQUAL S 25.9W 830 175x175mm	Number	1
Line	Eulumat	Date	01-12-2014	Position	
Efficiency	100.00%	Coordinate system	CG	Total Flux	2370.06 lm

175mm x 175mm

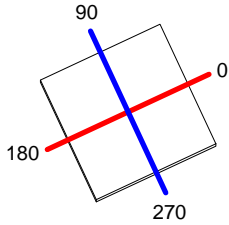

C Halfplanes

180.0 ——— 0.0
270.0 ——— 90.0

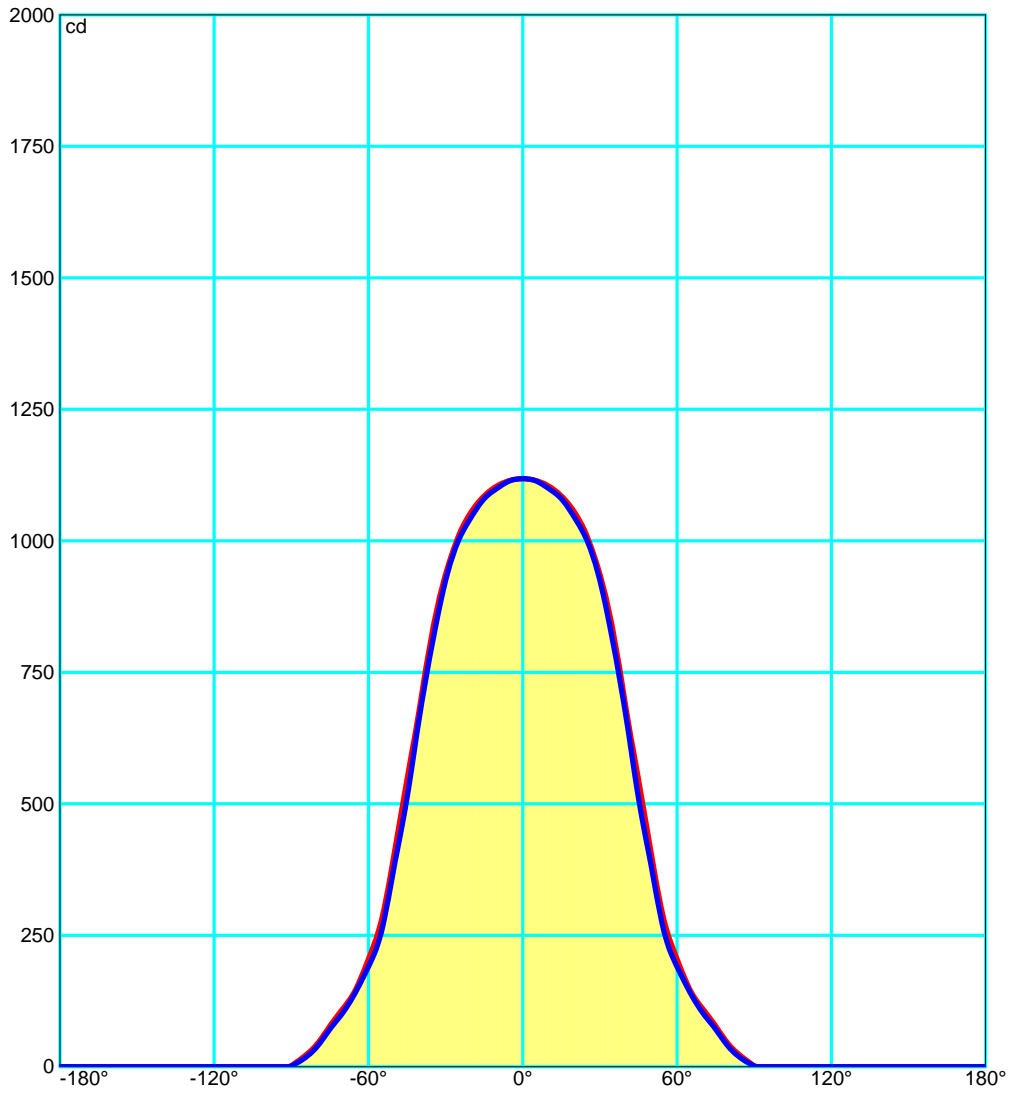

Luminaire	Measur.	Lamp
Code 90-2026	Code 90-2027	Code L2026 25.9W 80 3000K
Name EQUAL S 25.9W 830 175x175mm	Name EQUAL S 25.9W 830 175x175mm	Number 1
Line Eulumdat	Date 01-12-2014	Position
Efficiency 100.00%	Coordinate system CG	Total Flux 2370.06 lm

UGR
S = 0.250

Reflectancies										
Ceiling/Cavity	0.7	0.7	0.5	0.5	0.3	0.7	0.7	0.5	0.5	0.3
Walls	0.5	0.3	0.5	0.3	0.3	0.5	0.3	0.5	0.3	0.3
WorkingPlane	0.2	0.2	0.2	0.2	0.2	0.2	0.2	0.2	0.2	0.2
RoomDimensions	ViewedCrosswise					ViewedEndwise				
x=2H y=2H	23.1	24.2	23.4	24.4	24.7	23.1	24.2	23.4	24.4	24.7
x=2H y=3H	23.8	24.8	24.1	25.0	25.3	23.8	24.8	24.1	25.0	25.3
x=2H y=4H	24.1	25.1	24.4	25.3	25.6	24.1	25.0	24.4	25.3	25.6
x=2H y=6H	24.3	25.2	24.7	25.5	25.7	24.3	25.1	24.6	25.4	25.7
x=2H y=8H	24.4	25.2	24.7	25.5	25.8	24.3	25.2	24.7	25.5	25.8
x=2H y=12H	24.4	25.2	24.8	25.5	25.8	24.3	25.1	24.7	25.5	25.8
x=4H y=2H	23.6	24.6	24.0	24.9	25.1	23.6	24.6	24.0	24.8	25.1
x=4H y=3H	24.5	25.3	24.8	25.6	25.9	24.5	25.3	24.8	25.6	25.9
x=4H y=4H	24.9	25.6	25.3	25.9	26.3	24.9	25.6	25.3	25.9	26.3
x=4H y=6H	25.2	25.8	25.6	26.2	26.5	25.1	25.7	25.6	26.1	26.5
x=4H y=8H	25.3	25.8	25.7	26.2	26.6	25.2	25.8	25.7	26.2	26.6
x=4H y=12H	25.4	25.9	25.8	26.3	26.6	25.3	25.8	25.7	26.2	26.6
x=8H y=4H	25.1	25.6	25.5	26.0	26.4	25.0	25.6	25.5	26.0	26.4
x=8H y=6H	25.4	25.9	25.9	26.3	26.7	25.4	25.9	25.9	26.3	26.7
x=8H y=8H	25.6	26.0	26.1	26.4	26.9	25.6	26.0	26.0	26.4	26.9
x=8H y=12H	25.7	26.0	26.2	26.5	27.0	25.6	26.0	26.1	26.5	27.0
x=12H y=4H	25.1	25.6	25.5	26.0	26.4	25.0	25.5	25.5	26.0	26.4
x=12H y=6H	25.5	25.9	25.9	26.3	26.8	25.4	25.8	25.9	26.3	26.8
x=12H y=8H	25.6	26.0	26.1	26.4	26.9	25.6	25.9	26.1	26.4	26.9

Luminaire	Measur.	Lamp
Code 90-2026	Code 90-2027	Code L2026 25.9W 80 3000K
Name EQUAL S 25.9W 830 175x175mm	Name EQUAL S 25.9W 830 175x175mm	Number 1
Line Eulumdat	Date 01-12-2014	Position

Efficiency 100.00%	Coordinate system CG	Total Flux 2370.06 lm
--------------------	----------------------	-----------------------

Total Flux=2370.06 Luminaire Flux=2370.06

RI	0.60	0.80	1.00	1.25	1.50	2.00	2.50	3.00	4.00	5.00	10.00	20.00
DRR	0.41	0.50	0.57	0.64	0.69	0.76	0.81	0.85	0.88	0.90	0.95	0.97
RC	3	3	3	3	3	3	3	3	3	3	2	2

Zonal Flux per 1000 Lumen

Y°	10	20	30	40	50	60	70	80	90	100	110	120	130	140	150	160	170	180
ZF(Y)	45	173	368	588	773	892	959	991	1000	1000	1000	1000	1000	1000	1000	1000	1000	1000

CIE Flux Codes

62 89 98 100 100

C.I.E.	3/3/3/3/3/3/3/3/2/2	LOR	99.99987 %
D DIN 5040	A50	ULOR	0.00000 %
F UTE	1.00 C	DLOR	99.99987 %
B NBN	BZ 3	UFF	0.00000 %
RN	0.00000 %	DFF	100.00000 %
BLF	1.0	FFR	0.00000 %

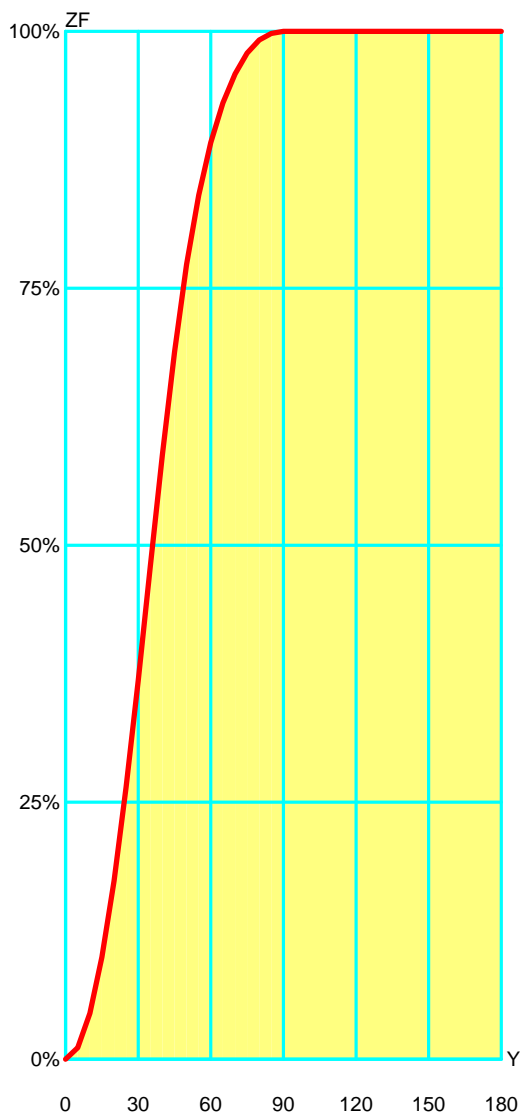

Zonal Flux				
Gamma °	Flux	Sum lm	Flux [%]	Sum [%]
0°	0.00	0.00	0.00%	0.00 %
5°	11.26	11.26	1.13 %	1.13 %
10°	33.43	44.69	3.34 %	4.47 %
15°	54.62	99.31	5.46 %	9.93 %
20°	74.15	173.46	7.42 %	17.35 %
25°	91.06	264.52	9.11 %	26.45 %
30°	103.93	368.45	10.39 %	36.84 %
35°	110.54	478.98	11.05 %	47.90 %
40°	109.30	588.28	10.93 %	58.83 %
45°	99.98	688.26	10.00 %	68.83 %
50°	85.03	773.29	8.50 %	77.33 %
55°	67.40	840.69	6.74 %	84.07 %
60°	51.12	891.81	5.11 %	89.18 %
65°	38.52	930.32	3.85 %	93.03 %
70°	28.25	958.58	2.83 %	95.86 %
75°	20.14	978.72	2.01 %	97.87 %
80°	12.74	991.46	1.27 %	99.15 %
85°	6.42	997.88	0.64 %	99.79 %
90°	2.11	1000.00	0.21 %	100.00 %
95°	0.00	1000.00	0.00 %	100.00 %
100°	0.00	1000.00	0.00 %	100.00 %
105°	0.00	1000.00	0.00 %	100.00 %
110°	0.00	1000.00	0.00 %	100.00 %
115°	0.00	1000.00	0.00 %	100.00 %
120°	0.00	1000.00	0.00 %	100.00 %
125°	0.00	1000.00	0.00 %	100.00 %
130°	0.00	1000.00	0.00 %	100.00 %
135°	0.00	1000.00	0.00 %	100.00 %
140°	0.00	1000.00	0.00 %	100.00 %
145°	0.00	1000.00	0.00 %	100.00 %
150°	0.00	1000.00	0.00 %	100.00 %
155°	0.00	1000.00	0.00 %	100.00 %
160°	0.00	1000.00	0.00 %	100.00 %
165°	0.00	1000.00	0.00 %	100.00 %
170°	0.00	1000.00	0.00 %	100.00 %
175°	0.00	1000.00	0.00 %	100.00 %
180°	0.00	1000.00	0.00 %	100.00 %

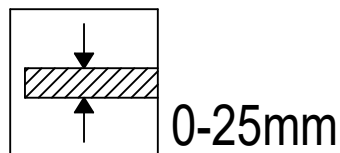
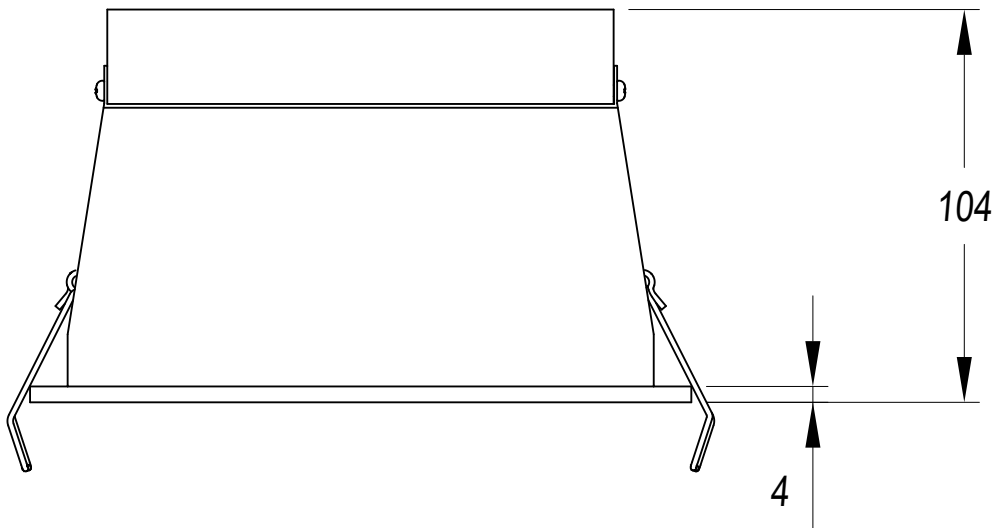
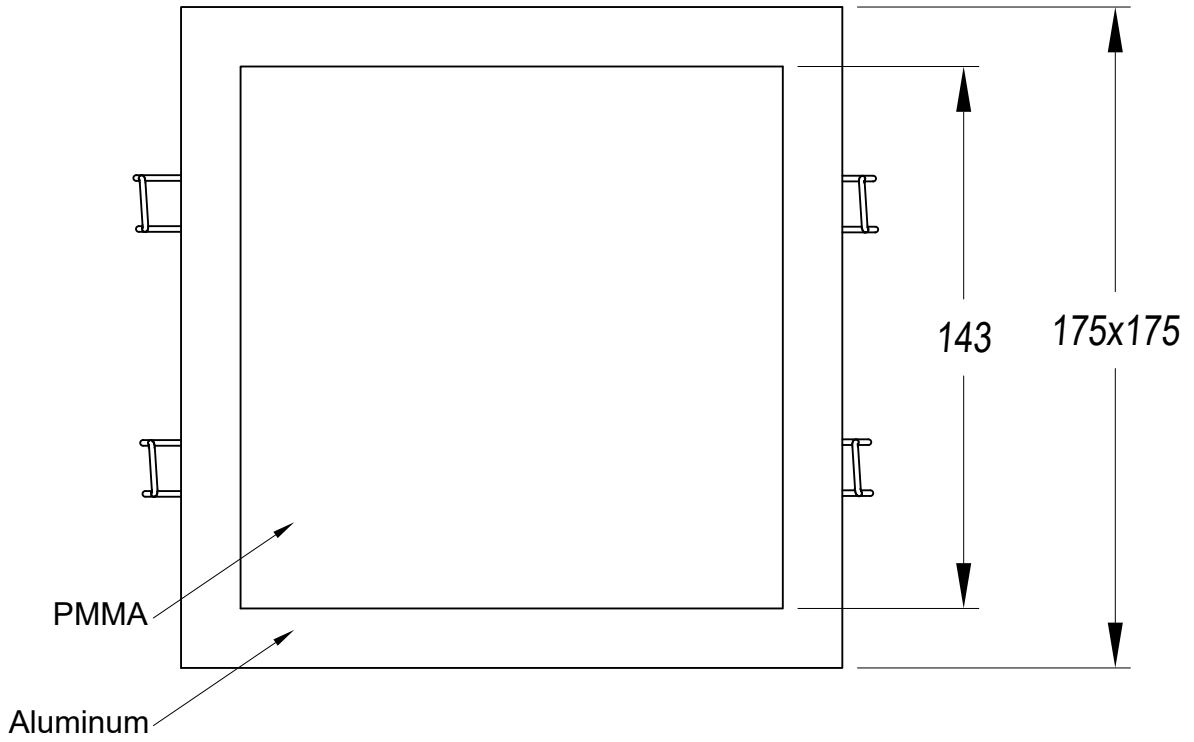

1

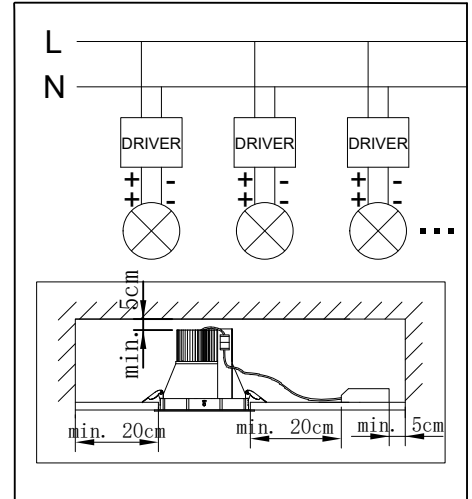
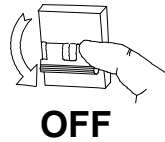
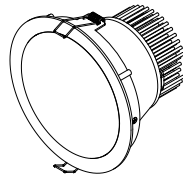
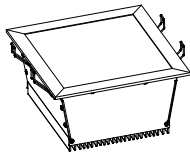

2

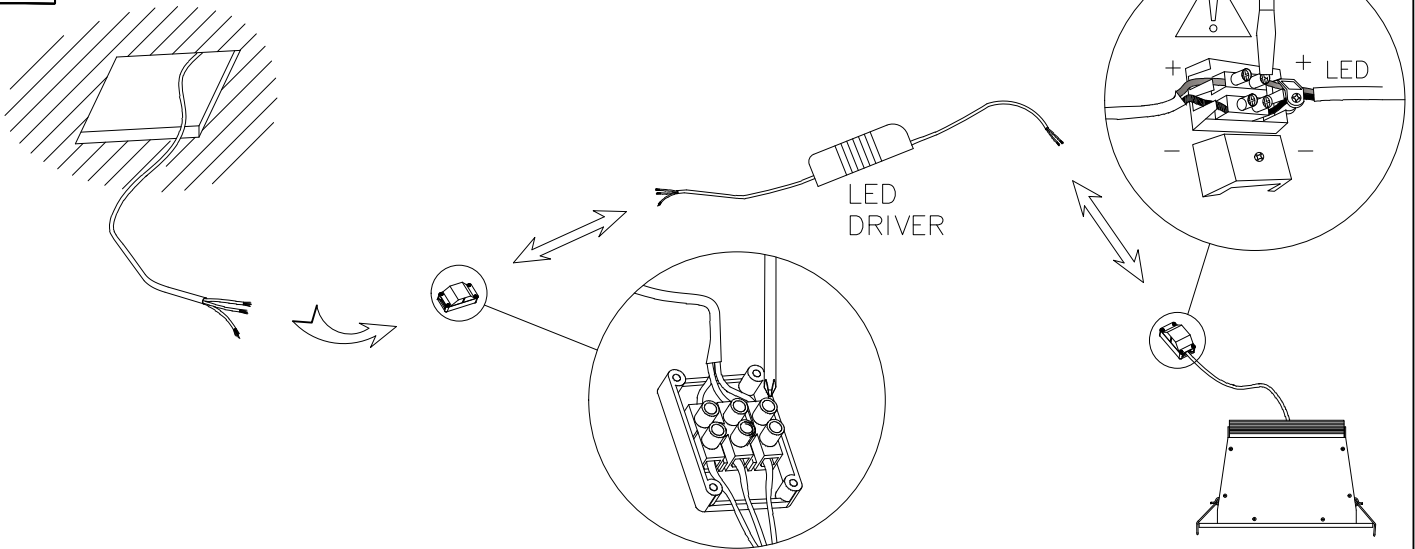

3

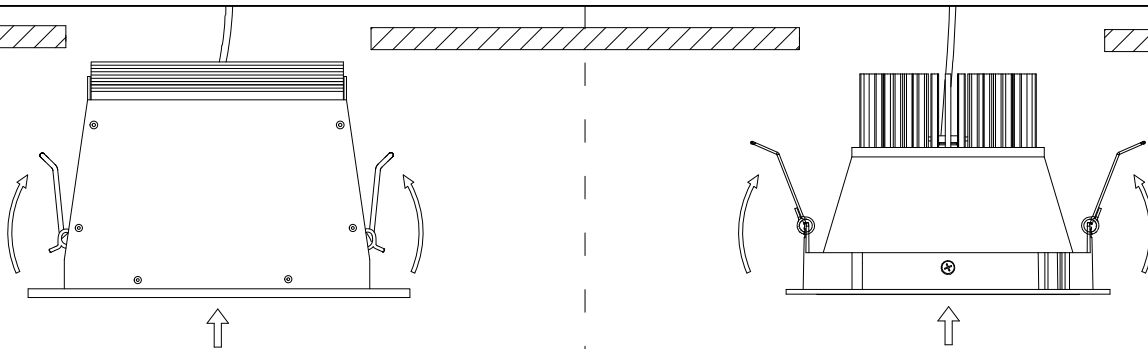

4

