

BOND TUBE MEDIUM 35-5411-60-DU

Spotlight BOND TUBE MEDIUM 25.9W 3000K CRI 80 DALI Black 2028lm

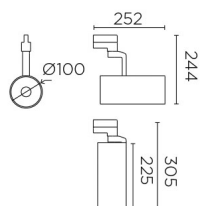

TECHNICAL FEATURES

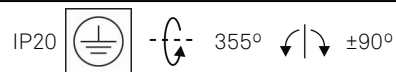

Power (W) : 25.9W
Total power consumption of light (W) : 26.7W
Raw lumens : 2028
Raw lm/W : 76
Colour temperature : LED warm-white 3000K
Structure material : Aluminium
Structure finish : Black
Diffuser material : Glass
Diffuser finish : Transparent
Useful life : 50.000h L80B20

Equipment included : Yes, electronic
Brand : HEP
Voltage / frequency : 100-277VAC/50-60Hz
Warranty : 2 Years
Max. temperature : 25°C

LUMINOTECHNIC FEATURES

Light source: LED CREE
CRI: 80
MacAdam steps: 2
Photobiological risk: RG1

LOGISTICS

Net weight (kg): 1.77
Packaged weight (kg): 1.96
Packaging: 105mm x 105mm x 350mm



Luminaire

Code 35-5411
 Name Proyector BON TUBE MEDIUM 30° 25.9W

Measurerm.

Code 35-5411
 Name Proyector BON TUBE MEDIUM 30° 25.9W

Luminaire Flux	2028.16 lm	Luminaire Power	25.90 W	Efficacy	78.31 lm/W	Efficiency	100.00%
Lamps Flux	2028.17 lm	Maximum value	5810.20 cd	Position	C=0.00 G=0.00	CG	Double Symmetrical
Round Luminaire Round Luminous Area		Diam.	100 mm	Height	225 mm		
		Diam.	100 mm	Height	0 mm		
Horizontal Luminous Area	0.007854 m2			Emitting area on Plane 180°	0.000000 m2		
Emitting area on Plane 0°	0.000000 m2			Emitting area on Plane 270°	0.000000 m2		
Emitting area on Plane 90°	0.000000 m2			Glare area at 76°	0.001900 m2		
Coordinate system	CG			Symmetry Type	Double Symmetrical		
Date	09-02-2016			Maximum Gamma Angle	90		
Measurement Distance	0.00			Measurement Flux	2028.17 lm		
Operator	Asselum T2			Source voltage			
Temperature	25.00 °C			Source current			
Humidity	60.00 %			Photocell			
Notes							

Line	Code	Luminaire Lamps		Flux [lm]	Pow. [W]	Q.ty
		Name				
	L3935 25.9W 80 3000K	Name	L3935 25.9W 80 3000K - 25.90 W	2028.17	25.90	1
C.I.E.	99 100 100 100 100		D DIN 5040	A60		
F UTE	--		B NBN	BZ 1		

Diam=100mm

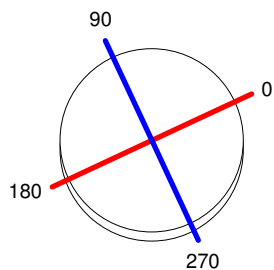

C Halfplanes

180.0 — 0.0
 270.0 — 90.0

ULOR 0.00 %
 DLOR 100.00 %
 RN 0.00 %

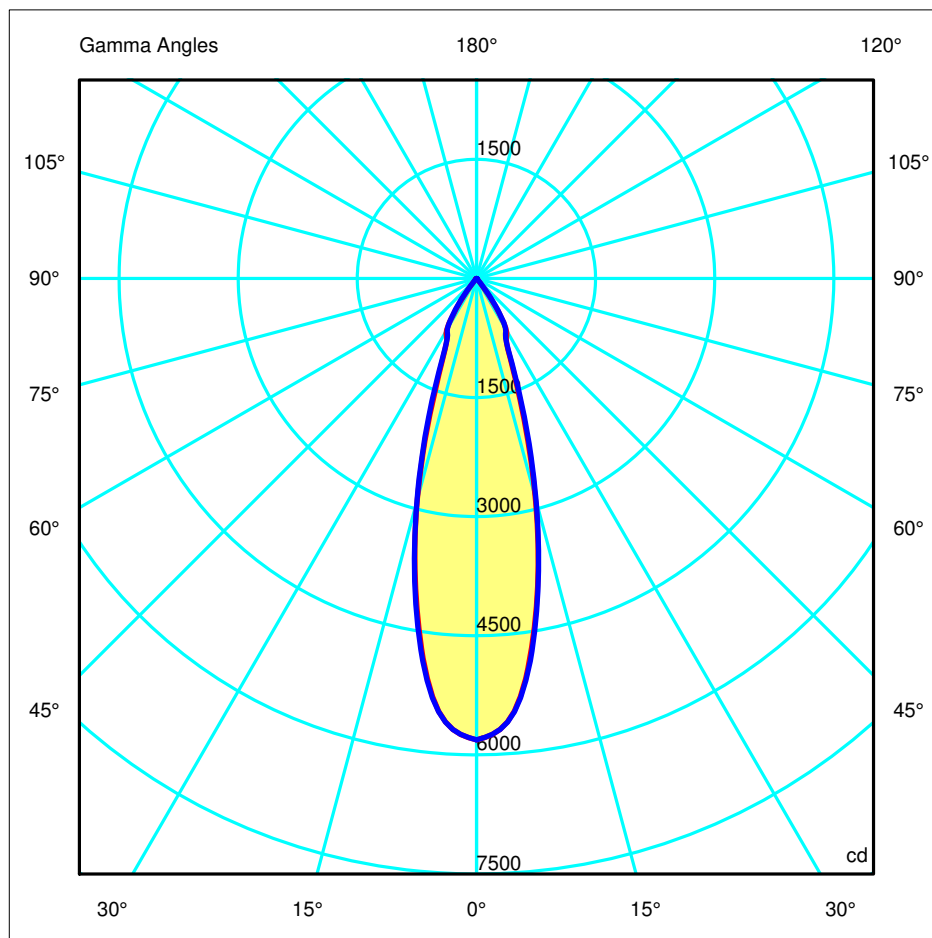

Luminaire

Code 35-5411
 Name Projector BON TUBE MEDIUM 30° 25.9W

Measur.

Code 35-5411
 Name Projector BON TUBE MEDIUM 30° 25.9W

Luminaire Flux	2028.16 lm	Luminaire Power	25.90 W	Efficacy	78.31 lm/W	Efficiency	100.00%
Lamps Flux	2028.17 lm	Maximum value	5810.20 cd	Position	C=0.00 G=0.00	CG	Double Symmetrical

Diam=100mm

C Halfplanes

180.0 ——— 0.0
 270.0 ——— 90.0

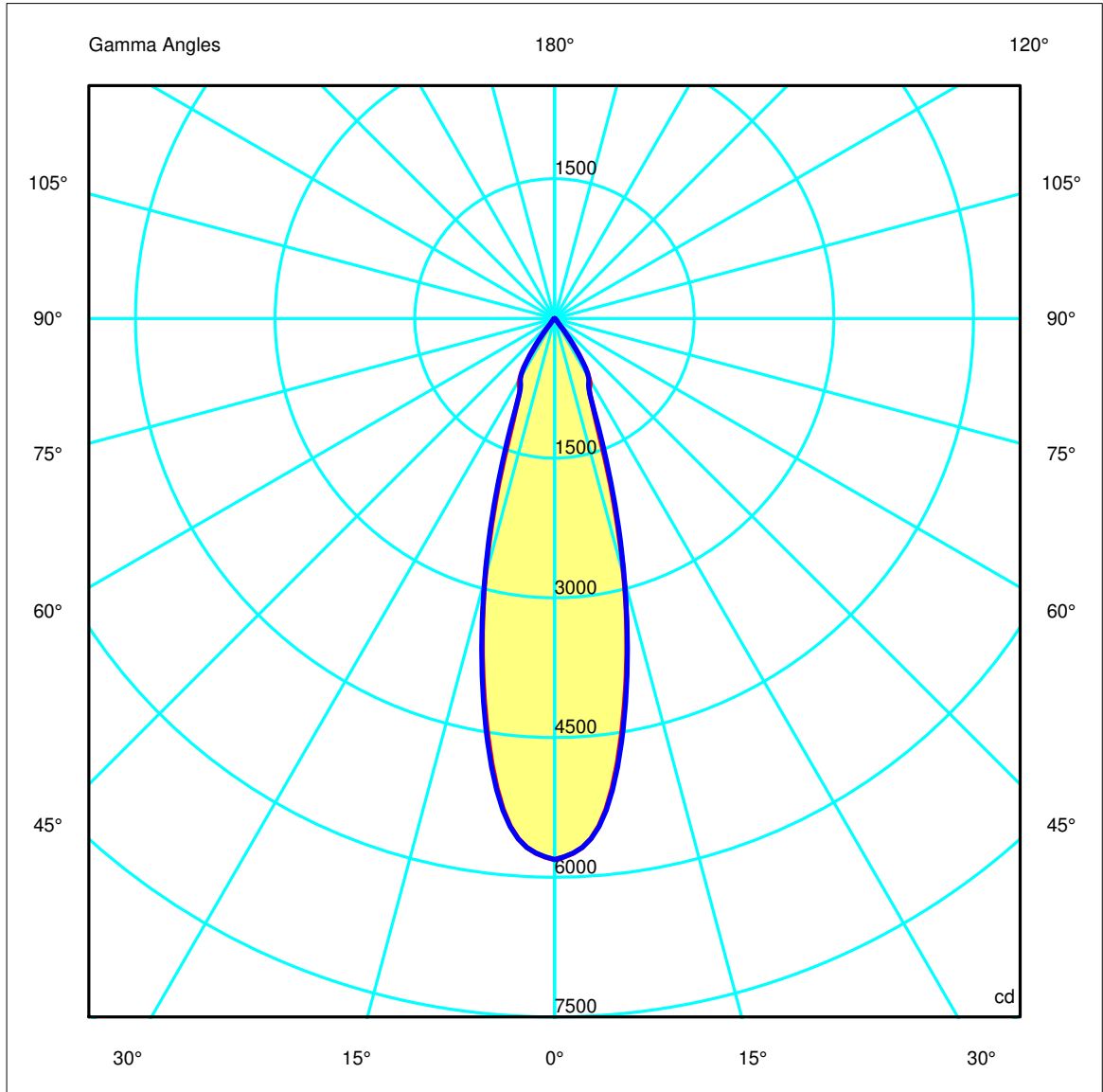
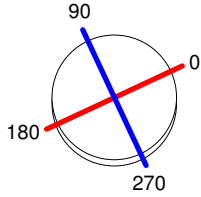

Luminaire

 Code 35-5411
 Name Projector BON TUBE MEDIUM 30° 25.9W

Measurement

 Code 35-5411
 Name Projector BON TUBE MEDIUM 30° 25.9W

Luminaire Flux	2028.16 lm	Luminaire Power	25.90 W	Efficacy	78.31 lm/W	Efficiency	100.00%
Lamps Flux	2028.17 lm	Maximum value	5810.20 cd	Position	C=0.00 G=0.00	CG	Double Symmetrical

Width at 50.00 % of Max Intensity

H[m]	1.00	2.00	3.00	4.00	5.00	H[m]	1.00	2.00	3.00	4.00	5.00
OA	0.27	0.53	0.80	1.06	1.33	OC	0.27	0.53	0.80	1.07	1.34
OB	0.27	0.53	0.80	1.06	1.33	OD	0.27	0.53	0.80	1.07	1.34

	Luminous Intensities [cd]									
	0	5	15	25	35	45	55	65	75	85
OA	5810.20	5469.53	2875.89	899.50	353.74	20.78	9.40	3.31	0.68	0.19
OB	5810.20	5469.53	2875.89	899.50	353.74	20.78	9.40	3.31	0.68	0.19
OC	5810.20	5477.19	2897.57	898.69	406.33	21.07	10.25	3.39	0.71	0.18
OD	5810.20	5477.19	2897.57	898.69	406.33	21.07	10.25	3.39	0.71	0.18

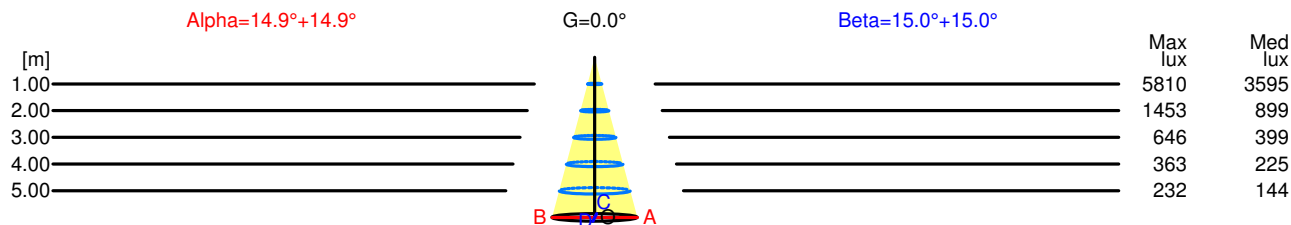

H[m]	D[m]	Max lux	Med lux	Alpha=14.9°+14.9°	G=0.0	
1.00	0.53	5810	3595			
2.00	1.06	1453	899			
3.00	1.60	646	399			
4.00	2.13	363	225			
5.00	2.66	232	144			

H[m]	D[m]	Max lux	Med lux	Beta=15.0°+15.0°	G=0.0	
1.00	0.53	5810	3595			
2.00	1.07	1453	899			
3.00	1.60	646	399			
4.00	2.14	363	225			
5.00	2.67	232	144			

Luminaire

Code 35-5411
 Name Proyector BON TUBE MEDIUM 30° 25.9W

Measurement

Code 35-5411
 Name Proyector BON TUBE MEDIUM 30° 25.9W

Luminaire Flux	2028.16 lm	Luminaire Power	25.90 W	Efficacy	78.31 lm/W	Efficiency	100.00%
Lamps Flux	2028.17 lm	Maximum value	5810.20 cd	Position	C=0.00 G=0.00	CG	Double Symmetrical

Isolux (Floor)

Luminaire position X=0.00m Y=0.00m Z=2.50m

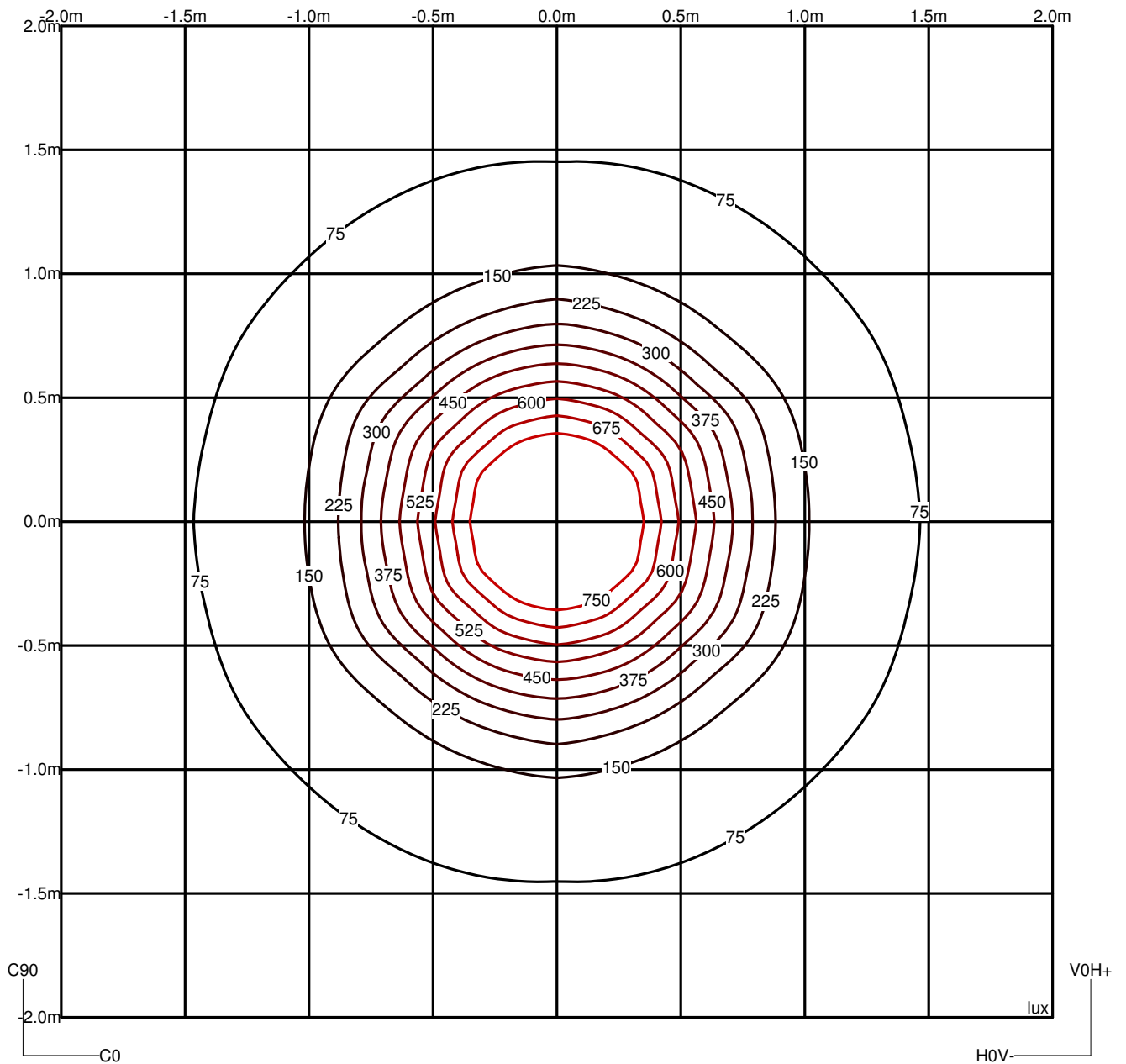

Luminaire

Code 35-5411
 Name Proyector BON TUBE MEDIUM 30° 25.9W

Measur.

Code 35-5411
 Name Proyector BON TUBE MEDIUM 30° 25.9W

Luminaire Flux	2028.16 lm	Luminaire Power	25.90 W	Efficacy	78.31 lm/W	Efficiency	100.00%
Lamps Flux	2028.17 lm	Maximum value	5810.20 cd	Position	C=0.00 G=0.00	CG	Double Symmetrical

		Average Luminance [cd/m ²]									
		45°	50°	55°	60°	65°	70°	75°	80°	85°	
0.0°		3741	3036	2087	1336	997	656	336	166	271	---
90.0°		3794	3198	2275	1390	1023	669	349	171	270	---

Flush mounted or longitudinal view												
		Illumination(lx)										
A	A	2000	1000	750	500		<300					1.15
B	1		2000	1500	1000	750	500	<300				1.5
C					2000		1000	500	<300			1.85
D	2						2000	1000	500	<300		2.2
E	3							2000	1000	500	<300	2.55

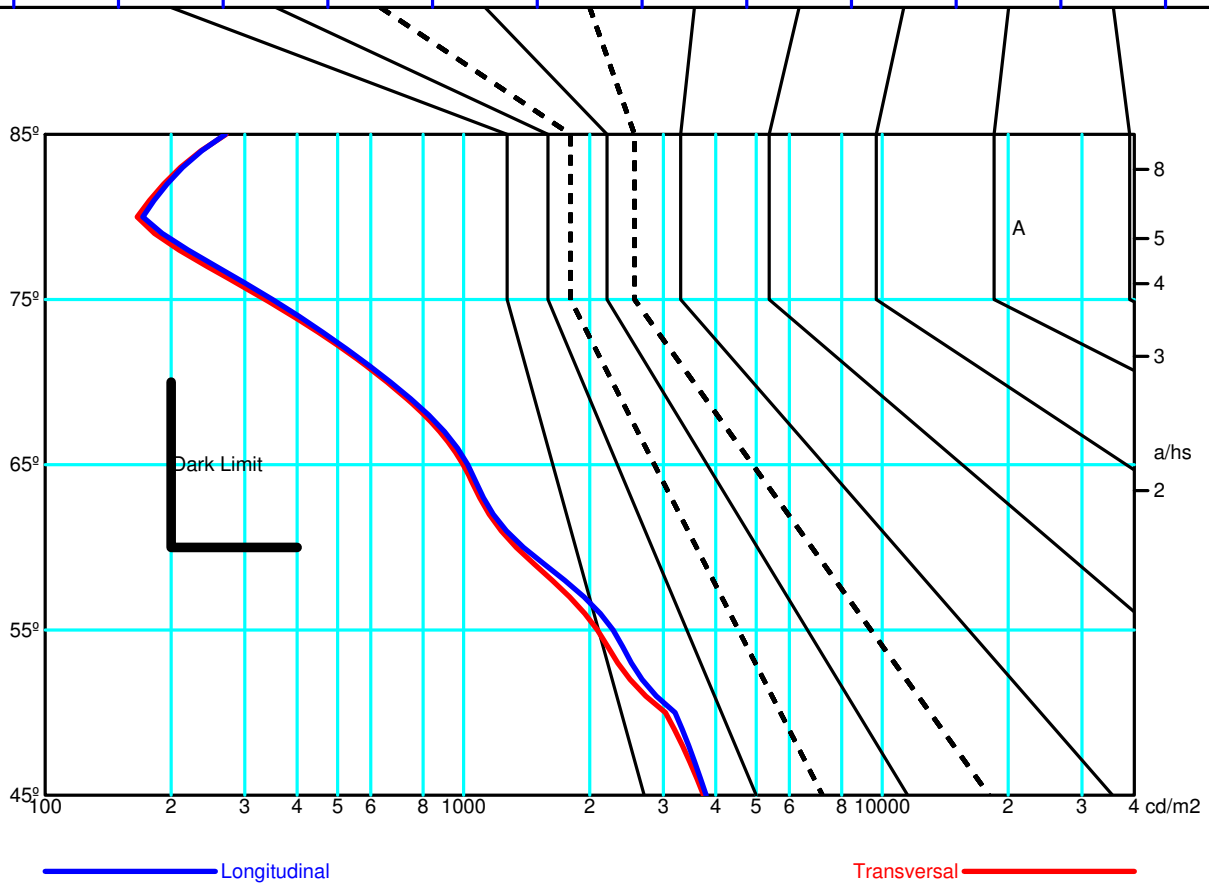

Luminaire

Code 35-5411
 Name Proyector BON TUBE MEDIUM 30° 25.9W

Measurem.

Code 35-5411
 Name Proyector BON TUBE MEDIUM 30° 25.9W

Luminaire Flux	2028.16 lm	Luminaire Power	25.90 W	Efficacy	78.31 lm/W	Efficiency	100.00%
Lamps Flux	2028.17 lm	Maximum value	5810.20 cd	Position	C=0.00 G=0.00	CG	Double Symmetrical

Diam=100mm

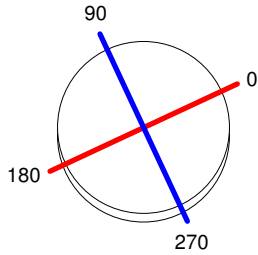

C Halfplanes

180.0 ——— 0.0
 270.0 ——— 90.0

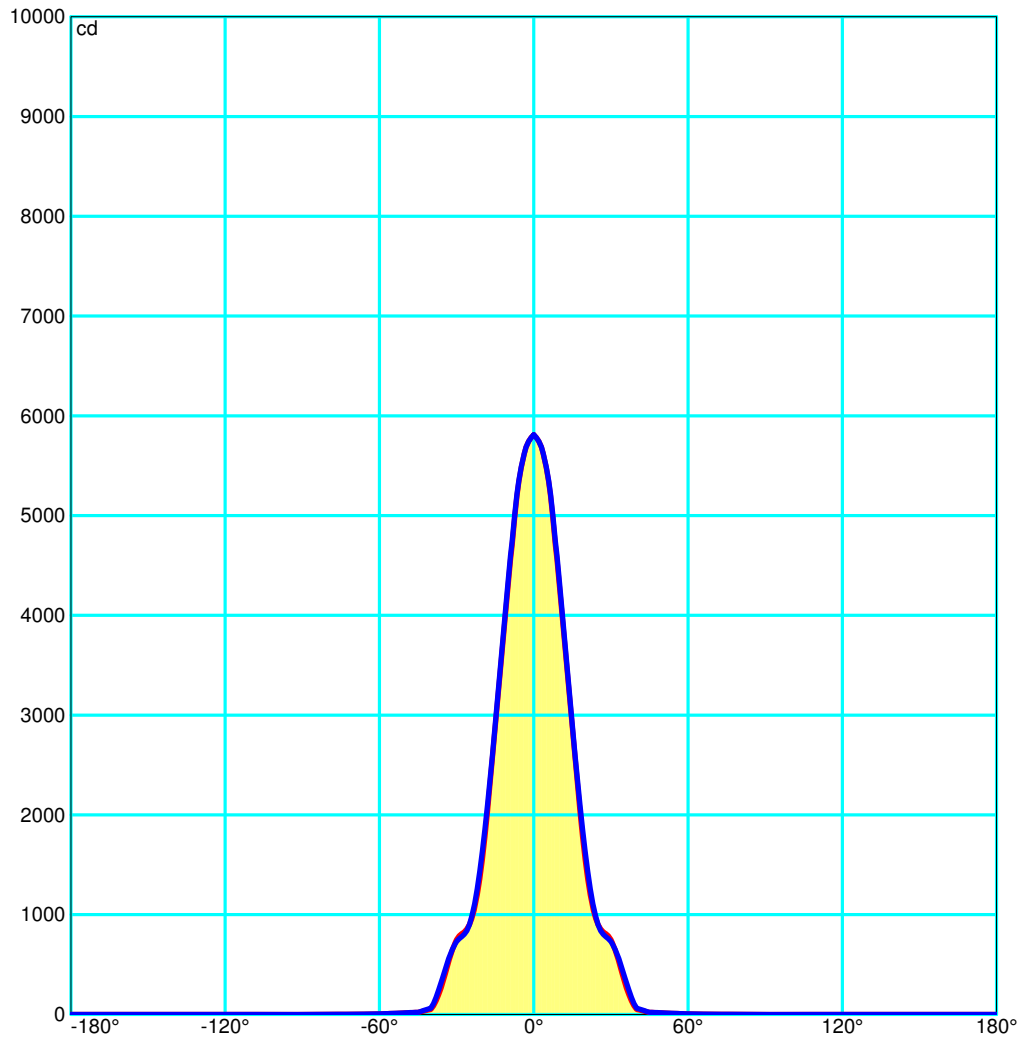

Luminaire

Code 35-5411
Name Proyector BON TUBE MEDIUM 30° 25.9W

Measurement

Code 35-5411
Name Proyector BON TUBE MEDIUM 30° 25.9W

Luminaire Flux	2028.16 lm	Luminaire Power	25.90 W	Efficacy	78.31 lm/W	Efficiency	100.00%
Lamps Flux	2028.17 lm	Maximum value	5810.20 cd	Position	C=0.00 G=0.00	CG	Double Symmetrical

UGR
S = 0.250

Reflectancies										
Ceiling/Cavity	0.7	0.7	0.5	0.5	0.3	0.7	0.7	0.5	0.5	0.3
Walls	0.5	0.3	0.5	0.3	0.3	0.5	0.3	0.5	0.3	0.3
WorkingPlane	0.2	0.2	0.2	0.2	0.2	0.2	0.2	0.2	0.2	0.2
RoomDimensions	ViewedCrosswise					ViewedEndwise				
x=2H y=2H	14.9	15.6	15.2	15.8	16.2	15.1	15.8	15.4	16.0	16.2
x=2H y=3H	14.8	15.4	15.1	15.6	16.1	15.0	15.6	15.3	15.8	16.1
x=2H y=4H	14.7	15.3	15.0	15.5	16.0	15.0	15.5	15.3	15.7	16.0
x=2H y=6H	14.7	15.2	15.0	15.4	16.0	14.9	15.4	15.2	15.7	16.0
x=2H y=8H	14.6	15.1	15.0	15.4	15.9	14.9	15.3	15.2	15.6	15.9
x=2H y=12H	14.6	15.0	14.9	15.4	15.9	14.8	15.3	15.2	15.6	15.9
x=4H y=2H	14.7	15.3	15.0	15.5	16.0	15.0	15.5	15.2	15.7	16.0
x=4H y=3H	14.6	15.1	15.0	15.4	15.9	14.8	15.3	15.2	15.6	15.9
x=4H y=4H	14.5	14.9	14.9	15.3	15.8	14.8	15.2	15.1	15.5	15.8
x=4H y=6H	14.5	14.8	14.9	15.2	15.7	14.7	15.0	15.1	15.4	15.7
x=4H y=8H	14.4	14.7	14.8	15.1	15.7	14.6	14.9	15.1	15.3	15.7
x=4H y=12H	14.4	14.6	14.8	15.0	15.7	14.6	14.8	15.0	15.3	15.7
x=8H y=4H	14.4	14.7	14.8	15.1	15.7	14.6	14.9	15.1	15.3	15.7
x=8H y=6H	14.3	14.6	14.8	15.0	15.6	14.6	14.8	15.0	15.2	15.6
x=8H y=8H	14.3	14.5	14.8	14.9	15.6	14.5	14.7	15.0	15.1	15.6
x=8H y=12H	14.2	14.4	14.7	14.8	15.6	14.5	14.6	14.9	15.1	15.6
x=12H y=4H	14.4	14.6	14.8	15.0	15.7	14.6	14.8	15.0	15.3	15.7
x=12H y=6H	14.3	14.5	14.8	14.9	15.6	14.5	14.7	15.0	15.1	15.6
x=12H y=8H	14.2	14.4	14.7	14.8	15.6	14.5	14.6	14.9	15.1	15.6

Luminaire

Code 35-5411
 Name Projector BON TUBE MEDIUM 30° 25.9W

Measurerm.

Code 35-5411
 Name Projector BON TUBE MEDIUM 30° 25.9W

Luminaire Flux	2028.16 lm	Luminaire Power	25.90 W	Efficacy	78.31 lm/W	Efficiency	100.00%
Lamps Flux	2028.17 lm	Maximum value	5810.20 cd	Position	C=0.00 G=0.00	CG	Double Symmetrical

Total Flux=2028.17 Luminaire Flux=2028.16

RI	0.60	0.80	1.00	1.25	1.50	2.00	2.50	3.00	4.00	5.00	10.00	20.00
DRR	0.73	0.78	0.82	0.86	0.88	0.93	0.95	0.97	0.99	1.00	1.02	1.02
RC	-	-	-	-	-	-	-	-	-	-	-	-

Zonal Flux per 1000 Lumen

Y°	10	20	30	40	50	60	70	80	90	100	110	120	130	140	150	160	170	180
ZF(Y)	239	633	865	982	993	998	999	1000	1000	1000	1000	1000	1000	1000	1000	1000	1000	1000

CIE Flux Codes

99 100 100 100 100

C.I.E.	-/-/-/-/-/-/-/-/-/-	LOR	99.99970 %
D DIN 5040	A60	ULOR	0.00000 %
F UTE	--	DLOR	99.99970 %
B NBN	BZ 1	UFF	0.00000 %
RN	0.00000 %	DFF	100.00000 %
BLF	1.0	FFR	0.00000 %

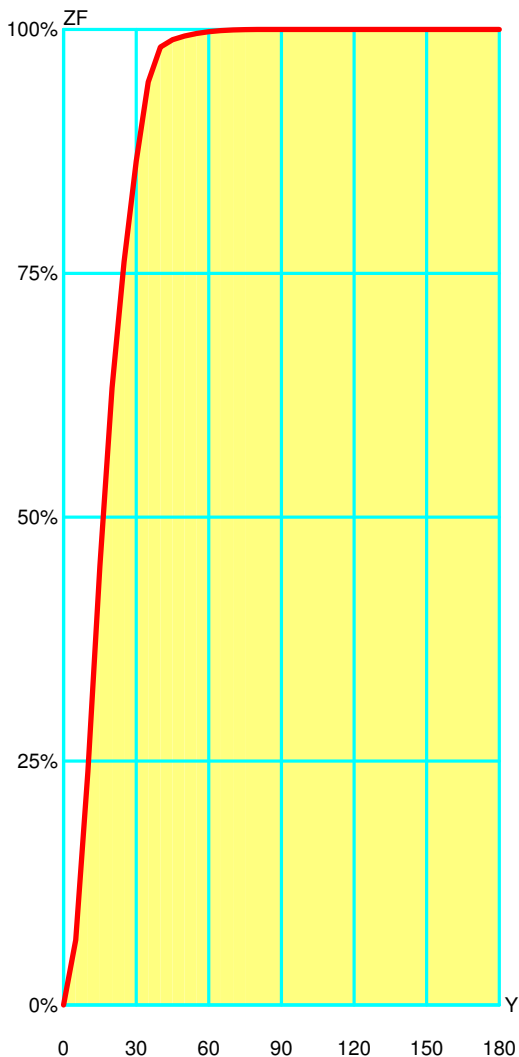

Gamma °	Zonal Flux			
	Flux	Sum lm	Flux [%]	Sum [%]
0°	0.00	0.00	0.00%	0.00 %
5°	66.59	66.59	6.66 %	6.66 %
10°	172.69	239.27	17.27 %	23.93 %
15°	210.72	449.99	21.07 %	45.00 %
20°	182.56	632.55	18.26 %	63.25 %
25°	129.19	761.74	12.92 %	76.17 %
30°	103.20	864.94	10.32 %	86.49 %
35°	81.28	946.23	8.13 %	94.62 %
40°	35.65	981.88	3.57 %	98.19 %
45°	7.59	989.47	0.76 %	98.95 %
50°	3.71	993.18	0.37 %	99.32 %
55°	2.74	995.93	0.27 %	99.59 %
60°	1.77	997.69	0.18 %	99.77 %
65°	1.07	998.77	0.11 %	99.88 %
70°	0.66	999.43	0.07 %	99.94 %
75°	0.33	999.76	0.03 %	99.98 %
80°	0.13	999.89	0.01 %	99.99 %
85°	0.06	999.95	0.01 %	100.00 %
90°	0.05	1000.00	0.00 %	100.00 %
95°	0.00	1000.00	0.00 %	100.00 %
100°	0.00	1000.00	0.00 %	100.00 %
105°	0.00	1000.00	0.00 %	100.00 %
110°	0.00	1000.00	0.00 %	100.00 %
115°	0.00	1000.00	0.00 %	100.00 %
120°	0.00	1000.00	0.00 %	100.00 %
125°	0.00	1000.00	0.00 %	100.00 %
130°	0.00	1000.00	0.00 %	100.00 %
135°	0.00	1000.00	0.00 %	100.00 %
140°	0.00	1000.00	0.00 %	100.00 %
145°	0.00	1000.00	0.00 %	100.00 %
150°	0.00	1000.00	0.00 %	100.00 %
155°	0.00	1000.00	0.00 %	100.00 %
160°	0.00	1000.00	0.00 %	100.00 %
165°	0.00	1000.00	0.00 %	100.00 %
170°	0.00	1000.00	0.00 %	100.00 %
175°	0.00	1000.00	0.00 %	100.00 %
180°	0.00	1000.00	0.00 %	100.00 %

Luminaire

Code 35-5411
 Name Projector BON TUBE MEDIUM 30° 25.9W

Measurum.

Code 35-5411
 Name Projector BON TUBE MEDIUM 30° 25.9W

Luminaire Flux	2028.16 lm	Luminaire Power	25.90 W	Efficacy	78.31 lm/W	Efficiency	100.00%
Lamps Flux	2028.17 lm	Maximum value	5810.20 cd	Position	C=0.00 G=0.00	CG	Double Symmetrical

Pavement			Road		
Piano	0	0.00%	Piano	0	0.00%
Piano	-5	13.97%	Piano	5	13.97%
Piano	-10	26.21%	Piano	10	26.21%
Piano	-15	35.29%	Piano	15	35.29%
Piano	-20	41.20%	Piano	20	41.20%
Piano	-25	44.97%	Piano	25	44.97%
Piano	-30	47.63%	Piano	30	47.63%
Piano	-35	49.13%	Piano	35	49.13%
Piano	-40	49.61%	Piano	40	49.61%
Piano	-45	49.76%	Piano	45	49.76%
Piano	-50	49.85%	Piano	50	49.85%
Piano	-55	49.91%	Piano	55	49.91%
Piano	-60	49.95%	Piano	60	49.95%
Piano	-65	49.97%	Piano	65	49.97%
Piano	-70	49.99%	Piano	70	49.99%
Piano	-75	49.99%	Piano	75	49.99%
Piano	-80	50.00%	Piano	80	50.00%
Piano	-85	50.00%	Piano	85	50.00%
Piano	-90	50.00%	Piano	90	50.00%

Tilting Angle = 0.0

DLOR = 100.00%

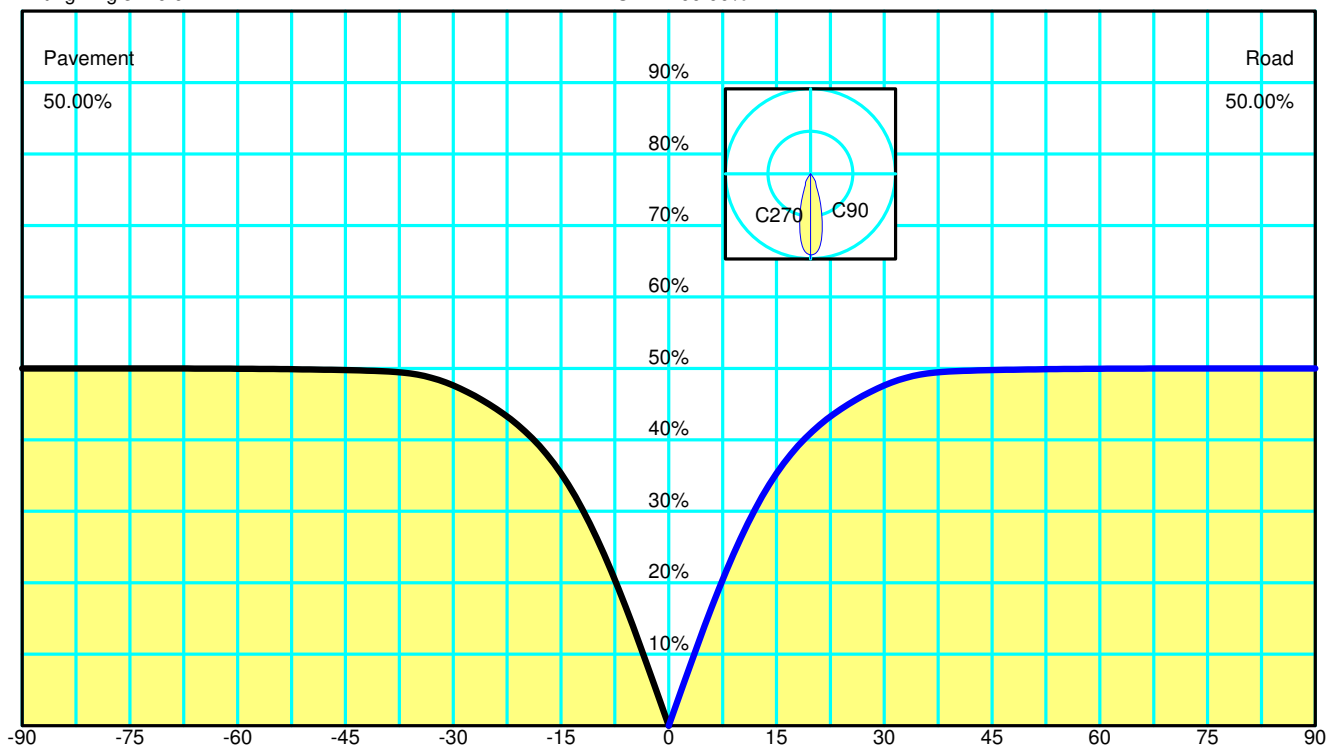

Spread	6.4° Narrow	DLOR	99.99970 %
Throw	3.2° Short	ULOR	0.00000 %
SLI (glare)	12.9 Tight	Efficiency	99.99970 %
CIE Cutoff	Cutoff - Max: C=0.0° Gamma=0.0°	RN	0.00000 %
lesna Cutoff	Cutoff	Luminous Intensity Class	G5
DIN5044	KB1	Glare Index	D6

IESNA Type V Very Short Quadrilateral Symmetry

Luminaire

 Code 35-5411
 Name Proyector BON TUBE MEDIUM 30° 25.9W

Measurerm.

 Code 35-5411
 Name Proyector BON TUBE MEDIUM 30° 25.9W

Luminaire Flux	2028.16 lm	Luminaire Power	25.90 W	Efficacy	78.31 lm/W	Efficiency	100.00%
Lamps Flux	2028.17 lm	Maximum value	5810.20 cd	Position	C=0.00 G=0.00	CG	Double Symmetrical

US ROAD STANDARDS

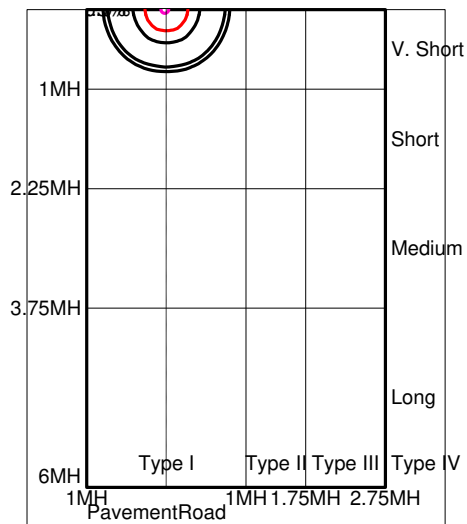
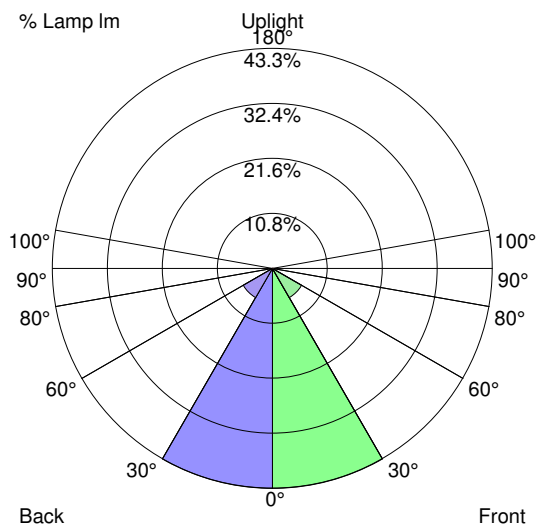

Luminaire Classification System (LCS)				
LCS Zone		Lumens	%Lamp	%Lum
FL	0° -- 30°	877.4 lm	43.3 %	43.3 %
FM	30° -- 60°	134.4 lm	6.6 %	6.6 %
FH	60° -- 80°	2.2 lm	0.1 %	0.1 %
FVH	80° -- 90°	0.1 lm	0.0 %	0.0 %
BL	0° -- 30°	877.4 lm	43.3 %	43.3 %
BM	30° -- 60°	134.4 lm	6.6 %	6.6 %
BH	60° -- 80°	2.2 lm	0.1 %	0.1 %
BVH	80° -- 90°	0.1 lm	0.0 %	0.0 %
UL	90° -- 100°	0.0 lm	0.0 %	0.0 %
UH	100° -- 180°	0.0 lm	0.0 %	0.0 %
TOTALS		2028.2 lm	100.0 %	100.0 %
		BUG B2 U0 G0	Type V Very Short	Quadrilateral Symmetry

