



MACH 3 Spotlight

Description

Spotlight MACH 3 38.6W 4000K CRI 80 Black 3054lm

	Finish	Material
Structure	Black	Aluminium
Diffuser	Transparent	Glass

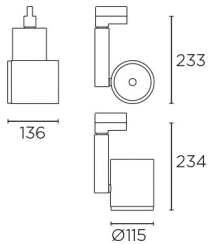

TECHNICAL CHARACTERISTICS

Light source

Light source: LED CREE
 Light source power (W): 38.6W
 Luminaire total power (W): 40.7W
 Color temperature: LED neutral-white 4000K
 CRI: 80
 Photobiological risk: RG1
 Real Lumen: 3054
 Qty Leds: 1
 Lm/Real W: 75
 Life Time: 50.000h L80B10
 Bin / Grup: 40H
 MacAdam steps: 2
 UGR: 15.0

GEAR

Brand: HEP
 Gear included: Yes, electronic
 Voltage / Frequency: 100-240VAC/50-60Hz
 Power Factor: 0.90

Luminaire

Warranty: 2 Years

Logistics

EAN Code: 8435381443177
 Net Weight (Kg): 1.5
 Weight in Kg (packaged): 1.82
 Packing: 170 x 140 x 280
 Masterbox: 8

The photograph may not match the reference exactly. Please read the product description to identify the finish.

OPTIONAL ACCESSORIES



ACT-9105-14-00

White trimless surface installation kit

Structure material: ABS
Dimensions: NA x NA x NA
Net Weight (Kg): 0.09



ACT-9106-14-00

Recessed box

Structure material: ABS
Dimensions: NA x NA x NA
Net Weight (Kg): 0.1

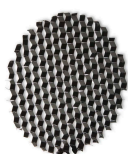

71-3896-60-00

Honeycomb panel accessory for Mach3 Big

Structure material: Aluminium
Dimensions: NA x NA x NA
Net Weight (Kg): 0.01



71-3897-60-00

Visual comfort accessory for Mach3 Big

Structure material: PVC
Dimensions: NA x NA x NA
Net Weight (Kg): 0.04



71-5629-14-00

White front ring accessory for Mach3 Big

Structure material: Polycarbonate
Dimensions: 113 x NA x 24
Net Weight (Kg): 0.05



71-5643-60-00

Elliptical diffuser accessory for Mach3 Big

Structure material: Polycarbonate
Dimensions: 98 x NA x 15
Net Weight (Kg): 0.02



71-5953-14-00

White trimless recessed installation kit

Structure material:
Dimensions: NA x NA x NA
Net Weight (Kg): 0.19



71-5953-60-00

Black trimless recessed installation kit

Structure material:
Dimensions: NA x NA x NA
Net Weight (Kg): 0.19

Luminaire		Measur.		Lamp	
Code	35-3938	Code	35-3938	Code	L3938 38.6W 80 4000K
Name	Projector MACH 3 840 30° 38.6W	Name	Projector MACH 3 840 30° 38.6W	Number	1
Line	Eulumdat	Date	16-10-2014	Position	
Efficiency	100.00%	Coordinate system	CG	Total Flux	3054.32 lm
Maximum value	8749.86 cd	Position	C=0.00 G=0.00	Double Symmetrical	
Round Luminaire	Diam.	115 mm	Height	135 mm	
Round Luminous Area	Diam.	110 mm	Height	0 mm	
Horizontal Luminous Area	0.009503 m2	Emitting area on Plane 180°	0.000000 m2		
Emitting area on Plane 0°	0.000000 m2	Emitting area on Plane 270°	0.000000 m2		
Emitting area on Plane 90°	0.000000 m2	Glare area at 76°	0.002299 m2		
Symmetry Type	Double Symmetrical	Maximum Gamma Angle	90		
Measurement Distance	0.00	Measurement Flux	3054.32 lm		
Operator	Asselum T2	Source voltage			
Temperature	25.00 °C	Source current			
Humidity	60.00 %	Photocell			
Notes					

Luminaire Lamps						
Line	Code	Name	Flux [lm]	Pow. [W]	Q.ty	
Eulumdat	L3938 38.6W 80 4000K	L3938 38.6W 80 4000K - 39.00 W	3054.32	39.00	1	
C.I.E.	99	100	100	100	100	D DIN 5040
F UTE	--					A60 B NBN

Diam=115mm

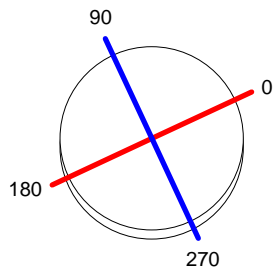

C Halfplanes

180.0 — 0.0 (Red line)

270.0 — 90.0 (Blue line)

ULOR 0.00 %
DLOR 100.00 %
RN 0.00 %

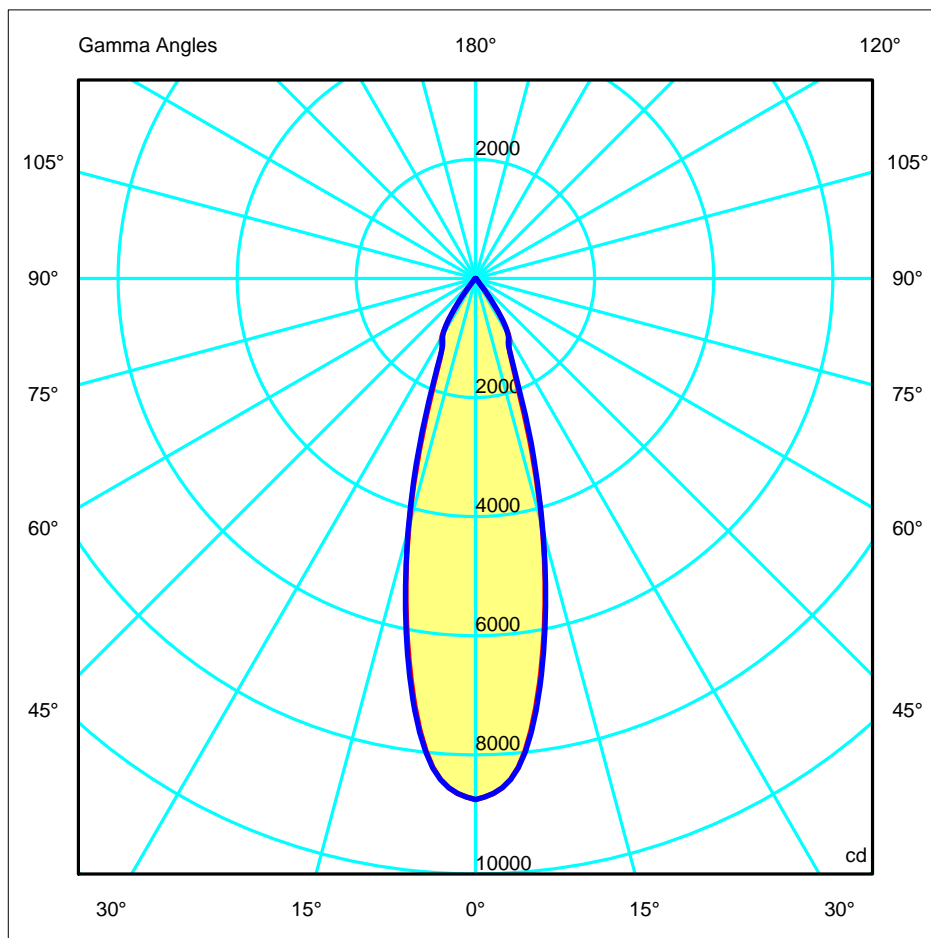

Luminaire		Measur.		Lamp	
Code	35-3938	Code	35-3938	Code	L3938 38.6W 80 4000K
Name	Projector MACH 3 840 30° 38.6W	Name	Projector MACH 3 840 30° 38.6W	Number	1
Line	Eulmdat	Date	16-10-2014	Position	
Efficiency	100.00%	Coordinate system	CG	Total Flux	3054.32 lm

Diam=115mm

C Halfplanes

180.0 ——— 0.0
 270.0 ——— 90.0

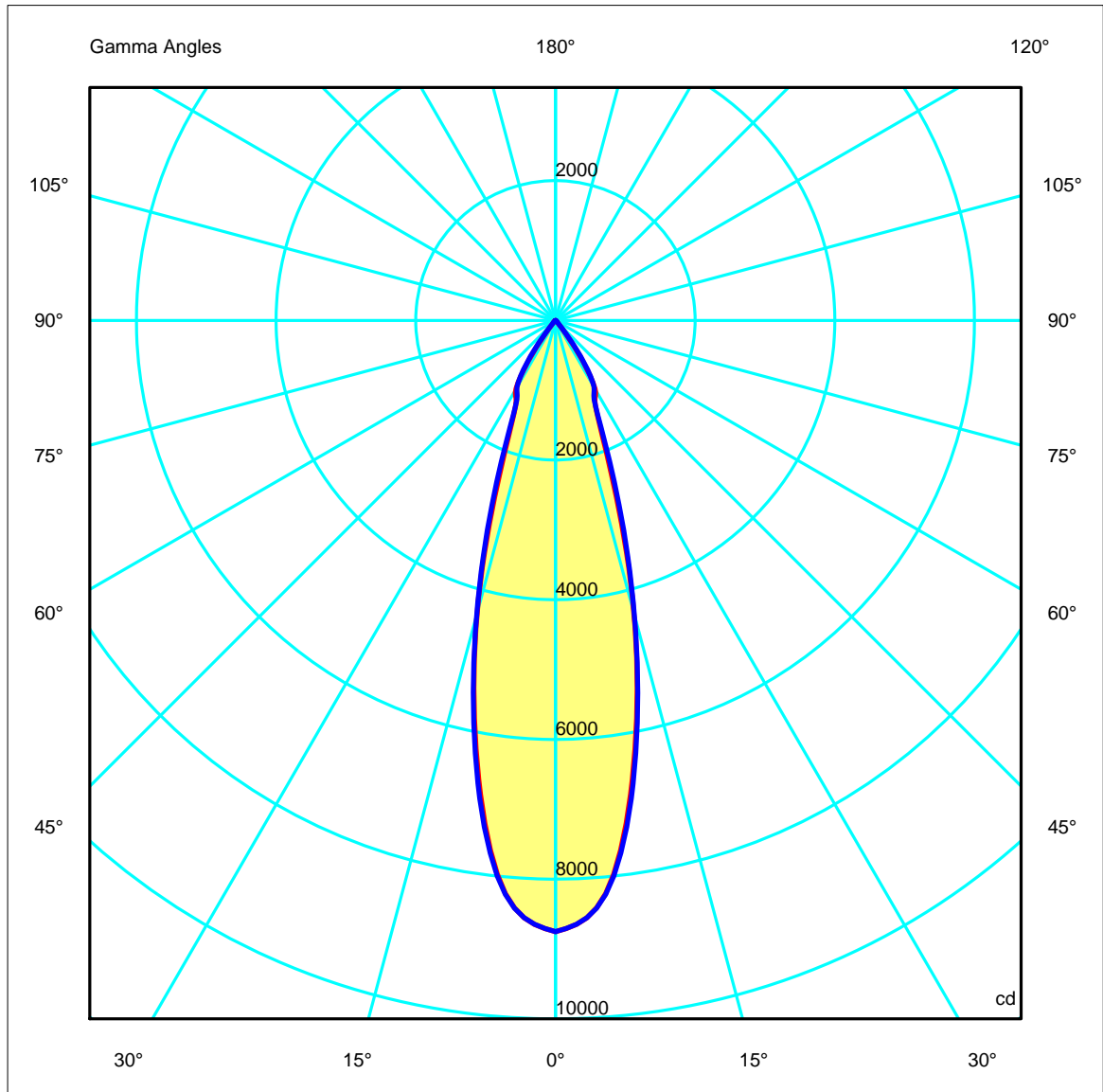
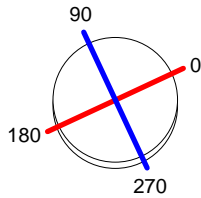

Luminaire		Measur.		Lamp	
Code	35-3938	Code	35-3938	Code	L3938 38.6W 80 4000K
Name	Projector MACH 3 840 30° 38.6W	Name	Projector MACH 3 840 30° 38.6W	Number	1
Line	Eulumdat	Date	16-10-2014	Position	
Efficiency	100.00%	Coordinate system	CG	Total Flux	3054.32 lm

Width at 50.00 % of Max Intensity

H[m]	1.00	2.00	3.00	4.00	5.00	H[m]	1.00	2.00	3.00	4.00	5.00
OA	0.27	0.53	0.80	1.06	1.33	OC	0.27	0.53	0.80	1.07	1.34
OB	0.27	0.53	0.80	1.06	1.33	OD	0.27	0.53	0.80	1.07	1.34

	Luminous Intensities [cd]									
	0	5	15	25	35	45	55	65	75	85
OA	8749.86	8236.83	4330.94	1354.60	532.72	31.29	14.16	4.98	1.03	0.28
OB	8749.86	8236.83	4330.94	1354.60	532.72	31.29	14.16	4.98	1.03	0.28
OC	8749.86	8248.37	4363.59	1353.39	611.91	31.73	15.44	5.11	1.07	0.28
OD	8749.86	8248.37	4363.59	1353.39	611.91	31.73	15.44	5.11	1.07	0.28

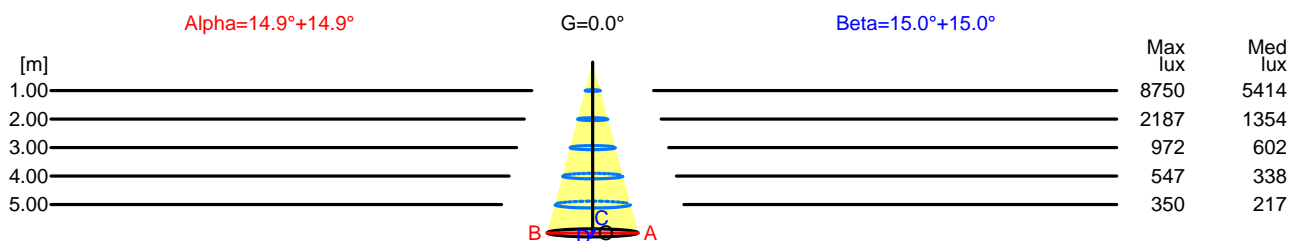

H[m]	D[m]	Max lux	Med lux	Alpha=14.9°+14.9°	G=0.0	
1.00	0.53	8750	5414			
2.00	1.06	2187	1354			
3.00	1.60	972	602			
4.00	2.13	547	338			
5.00	2.66	350	217			

H[m]	D[m]	Max lux	Med lux	Beta=15.0°+15.0°	G=0.0	
1.00	0.53	8750	5414			
2.00	1.07	2187	1354			
3.00	1.60	972	602			
4.00	2.14	547	338			
5.00	2.67	350	217			

Luminaire		Measur.		Lamp	
Code	35-3938	Code	35-3938	Code	L3938 38.6W 80 4000K
Name	Projector MACH 3 840 30° 38.6W	Name	Projector MACH 3 840 30° 38.6W	Number	1
Line	Eulumat	Date	16-10-2014	Position	
Efficiency	100.00%	Coordinate system	CG	Total Flux	3054.32 lm

Isolux (Floor)

Luminaire position X=0.00m Y=0.00m Z=3.00m

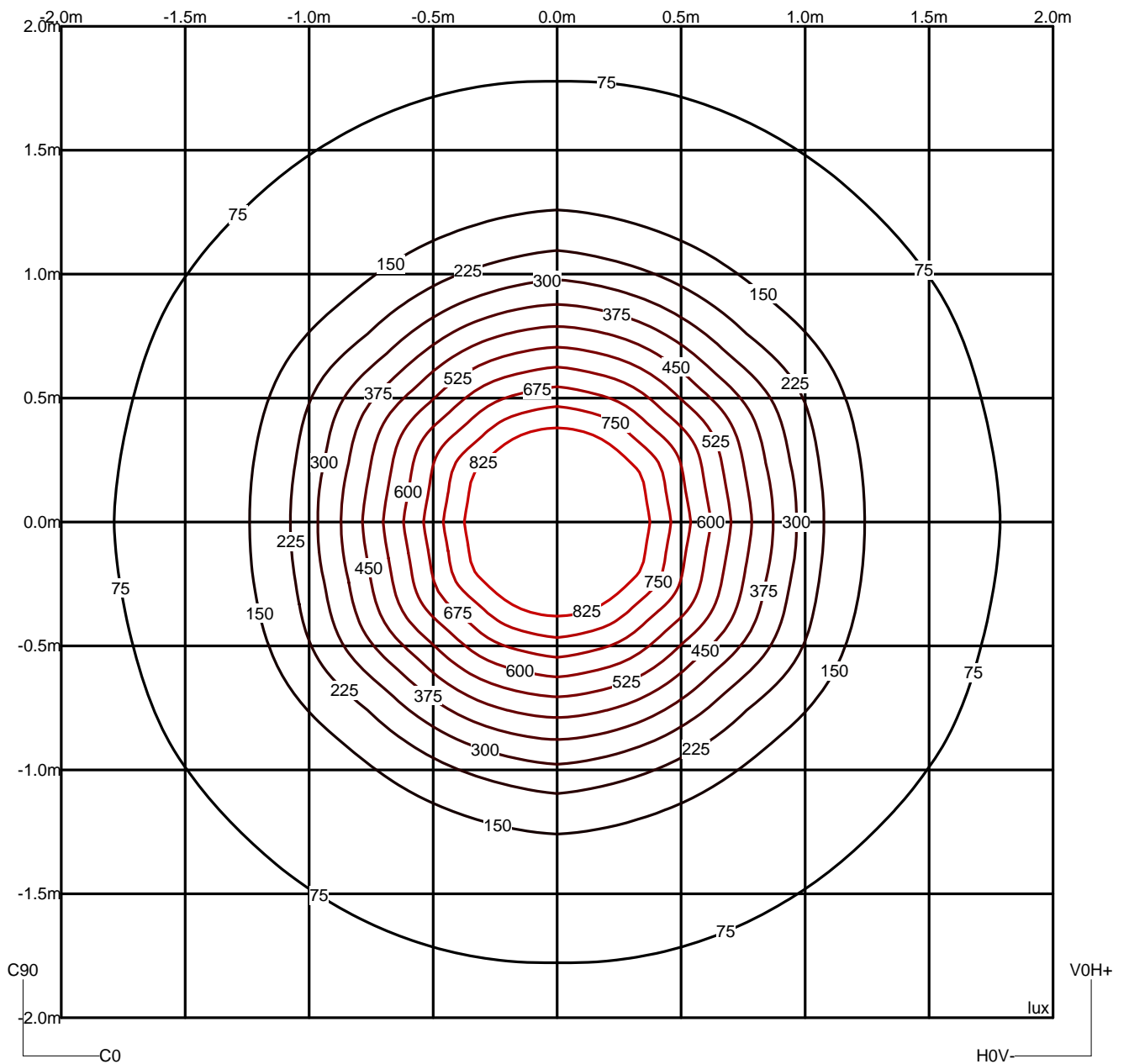

Luminaire

Code 35-3938
 Name Projector MACH 3 840 30° 38.6W
 Line Eulumdat

Measur.

Code 35-3938
 Name Projector MACH 3 840 30° 38.6W
 Date 16-10-2014

Lamp

Code L3938 38.6W 80 4000K
 Number 1
 Position

Efficiency 100.00% Coordinate system CG Total Flux 3054.32 lm

Average Luminance [cd/m ²]											
	0.0°	45°	50°	55°	60°	65°	70°	75°	80°	85°	
	0.0°	4657	3779	2598	1663	1241	817	418	207	337	---
	90.0°	4723	3980	2832	1730	1273	832	435	213	335	---

Flush mounted or longitudinal view												
		Illumination(lx)										
A	A	2000	1000	750	500		<300					1.15
B	1		2000	1500	1000	750	500	<300				1.5
C					2000		1000	500	<300			1.85
D	2						2000	1000	500	<300		2.2
E	3							2000	1000	500	<300	2.55

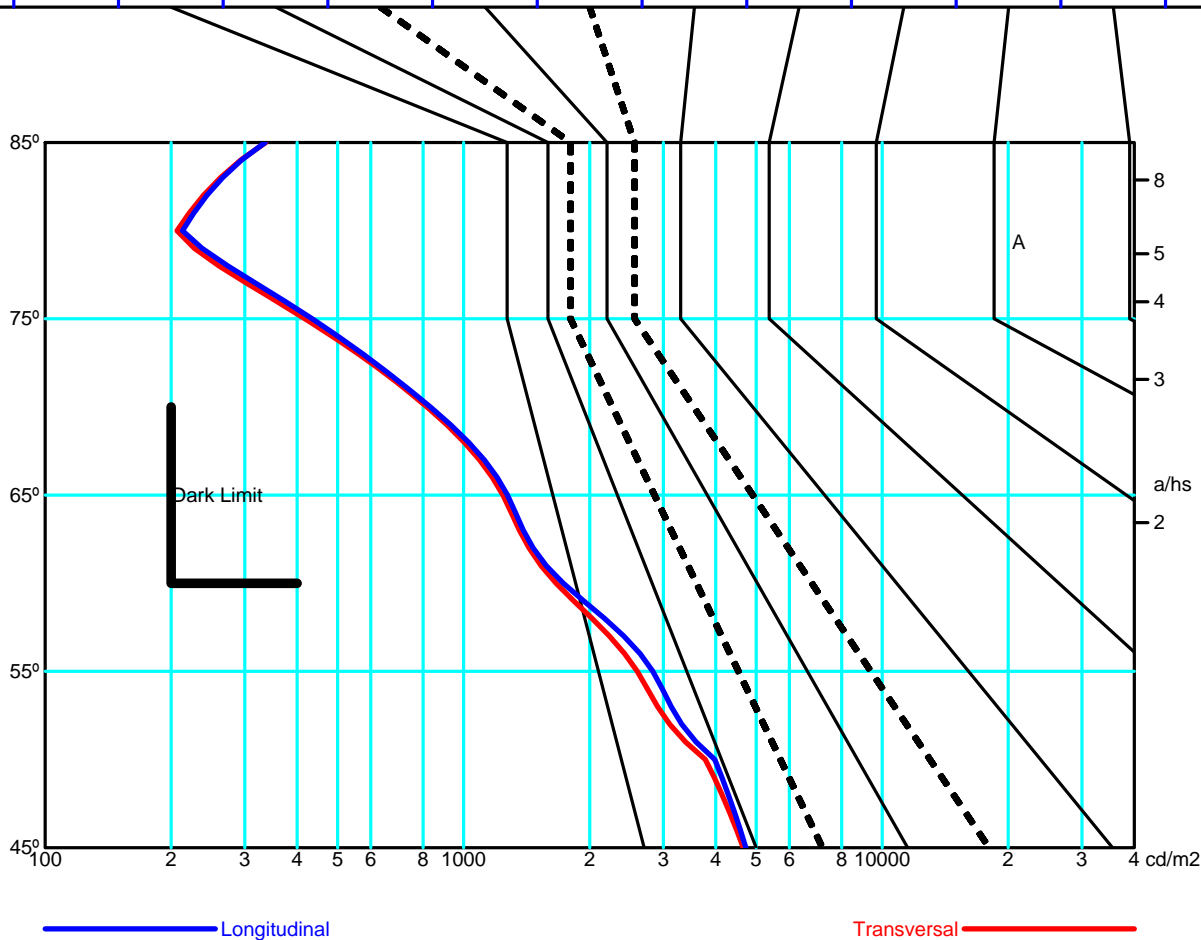

Luminaire		Measur.		Lamp	
Code	35-3938	Code	35-3938	Code	L3938 38.6W 80 4000K
Name	Projector MACH 3 840 30° 38.6W	Name	Projector MACH 3 840 30° 38.6W	Number	1
Line	Eulumdat	Date	16-10-2014	Position	
Efficiency	100.00%	Coordinate system	CG	Total Flux	3054.32 lm

Diam=115mm

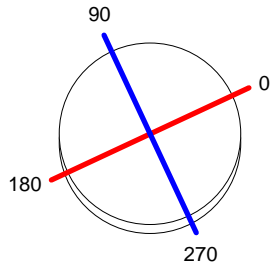

C Halfplanes

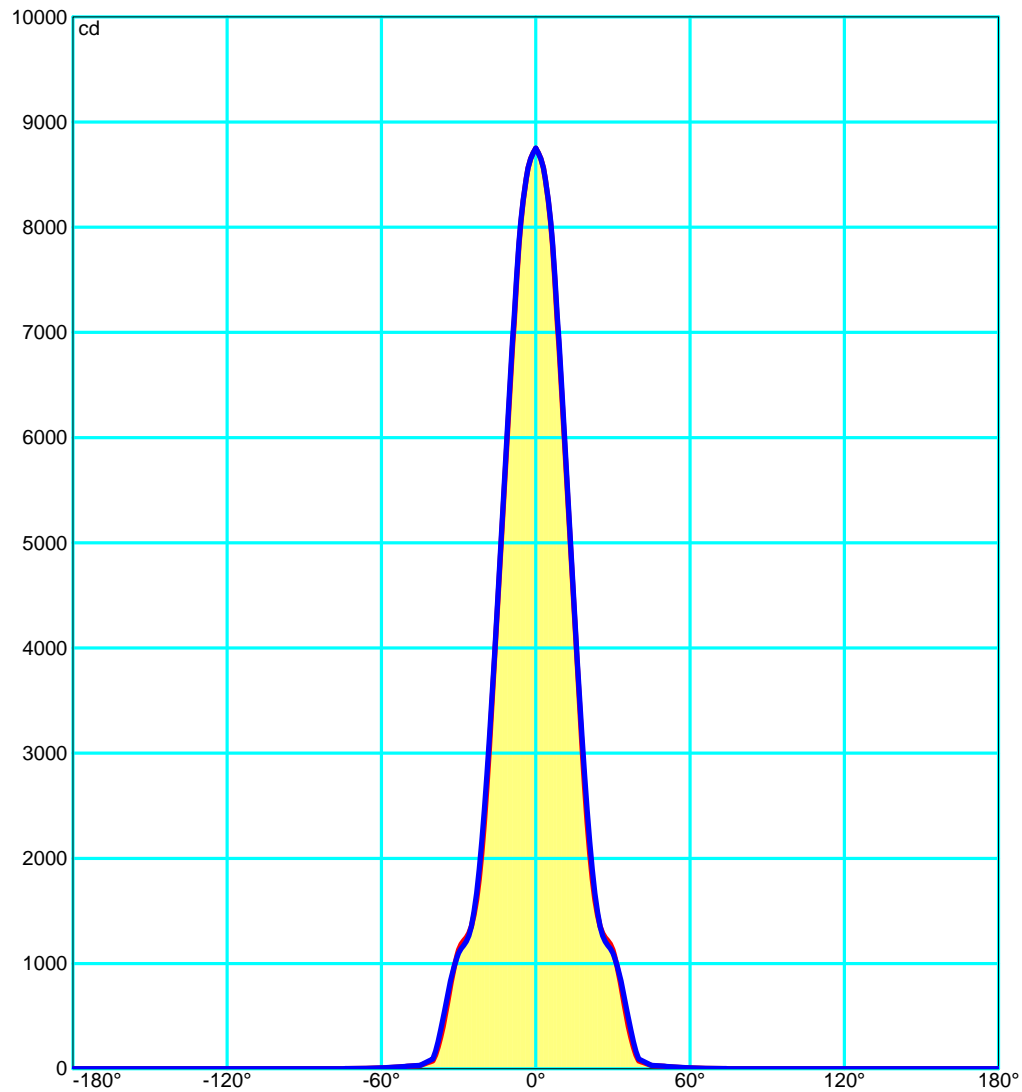

Luminaire		Measur.		Lamp	
Code	35-3938	Code	35-3938	Code	L3938 38.6W 80 4000K
Name	Proyector MACH 3 840 30° 38.6W	Name	Proyector MACH 3 840 30° 38.6W	Number	1
Line	Eulumat	Date	16-10-2014	Position	
Efficiency	100.00%	Coordinate system	CG	Total Flux	3054.32 lm

UGR
S = 0.250

Reflectancies										
Ceiling/Cavity	0.7	0.7	0.5	0.5	0.3	0.7	0.7	0.5	0.5	0.3
Walls	0.5	0.3	0.5	0.3	0.3	0.5	0.3	0.5	0.3	0.3
WorkingPlane	0.2	0.2	0.2	0.2	0.2	0.2	0.2	0.2	0.2	0.2
RoomDimensions	ViewedCrosswise					ViewedEndwise				
x=2H y=2H	15.7	16.3	15.9	16.5	16.9	15.9	16.5	16.1	16.7	16.9
x=2H y=3H	15.6	16.1	15.8	16.4	16.8	15.8	16.4	16.1	16.6	16.8
x=2H y=4H	15.5	16.0	15.8	16.3	16.8	15.7	16.3	16.0	16.5	16.8
x=2H y=6H	15.4	15.9	15.7	16.2	16.7	15.7	16.2	16.0	16.4	16.7
x=2H y=8H	15.4	15.9	15.7	16.2	16.7	15.6	16.1	15.9	16.4	16.7
x=2H y=12H	15.3	15.8	15.7	16.1	16.6	15.6	16.0	15.9	16.3	16.6
x=4H y=2H	15.5	16.0	15.8	16.3	16.8	15.7	16.3	16.0	16.5	16.8
x=4H y=3H	15.4	15.8	15.7	16.1	16.7	15.6	16.0	15.9	16.4	16.7
x=4H y=4H	15.3	15.7	15.7	16.0	16.6	15.5	15.9	15.9	16.2	16.6
x=4H y=6H	15.2	15.6	15.6	15.9	16.5	15.4	15.8	15.8	16.1	16.5
x=4H y=8H	15.2	15.5	15.6	15.8	16.5	15.4	15.7	15.8	16.1	16.5
x=4H y=12H	15.1	15.4	15.6	15.8	16.4	15.4	15.6	15.8	16.0	16.4
x=8H y=4H	15.2	15.5	15.6	15.8	16.5	15.4	15.7	15.8	16.1	16.5
x=8H y=6H	15.1	15.3	15.5	15.7	16.4	15.3	15.5	15.8	16.0	16.4
x=8H y=8H	15.0	15.2	15.5	15.7	16.3	15.3	15.4	15.7	15.9	16.3
x=8H y=12H	15.0	15.1	15.5	15.6	16.3	15.2	15.4	15.7	15.8	16.3
x=12H y=4H	15.1	15.4	15.6	15.8	16.4	15.4	15.6	15.8	16.0	16.4
x=12H y=6H	15.0	15.2	15.5	15.7	16.3	15.3	15.4	15.7	15.9	16.3
x=12H y=8H	15.0	15.1	15.5	15.6	16.3	15.2	15.4	15.7	15.8	16.3

Luminaire

Code 35-3938
 Name Proyector MACH 3 840 30° 38.6W
 Line Eulumdat

Measur.

Code 35-3938
 Name Proyector MACH 3 840 30° 38.6W
 Date 16-10-2014

Lamp

Code L3938 38.6W 80 4000K
 Number 1
 Position

Efficiency 100.00% Coordinate system CG Total Flux 3054.32 lm

Total Flux=3054.32 Luminaire Flux=3054.31

RI	0.60	0.80	1.00	1.25	1.50	2.00	2.50	3.00	4.00	5.00	10.00	20.00
DRR	0.73	0.78	0.82	0.86	0.88	0.93	0.95	0.97	0.99	1.00	1.02	1.02
RC	-	-	-	-	-	-	-	-	-	-	-	-

Zonal Flux per 1000 Lumen

Y°	10	20	30	40	50	60	70	80	90	100	110	120	130	140	150	160	170	180
ZF(Y)	239	633	865	982	993	998	999	1000	1000	1000	1000	1000	1000	1000	1000	1000	1000	1000

CIE Flux Codes

99 100 100 100 100

C.I.E.	-/-/-/-/-/-/-/-/-/-	LOR	99.99970 %
D DIN 5040	A60	ULOR	0.00000 %
F UTE	--	DLOR	99.99970 %
B NBN	BZ 1	UFF	0.00000 %
RN	0.00000 %	DFF	100.00000 %
BLF	1.0	FFR	0.00000 %

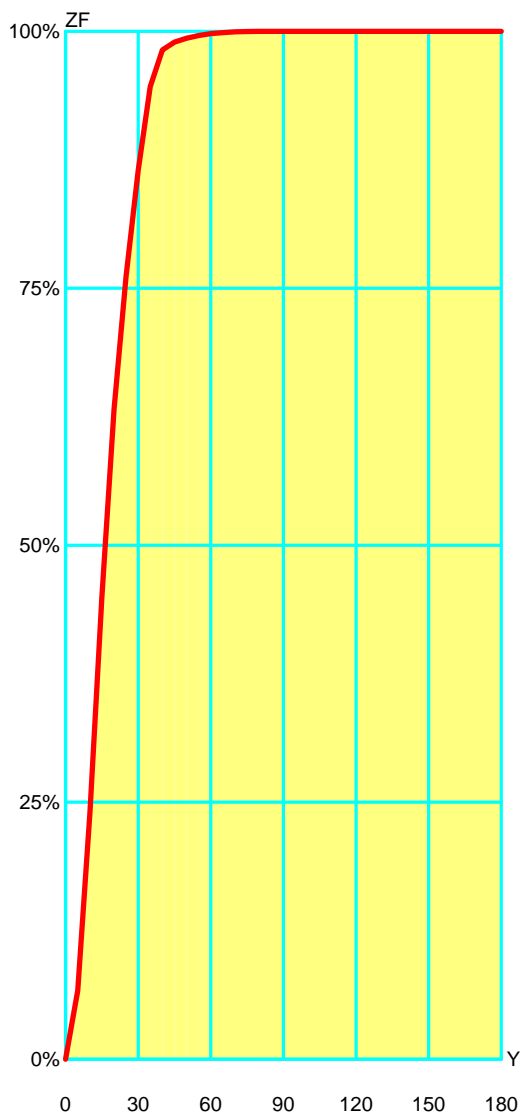

Zonal Flux				
Gamma °	Flux	Sum lm	Flux [%]	Sum [%]
0°	0.00	0.00	0.00%	0.00 %
5°	66.59	66.59	6.66 %	6.66 %
10°	172.69	239.27	17.27 %	23.93 %
15°	210.72	449.99	21.07 %	45.00 %
20°	182.56	632.55	18.26 %	63.25 %
25°	129.19	761.74	12.92 %	76.17 %
30°	103.20	864.94	10.32 %	86.49 %
35°	81.28	946.23	8.13 %	94.62 %
40°	35.65	981.88	3.57 %	98.19 %
45°	7.59	989.47	0.76 %	98.95 %
50°	3.71	993.18	0.37 %	99.32 %
55°	2.74	995.93	0.27 %	99.59 %
60°	1.77	997.69	0.18 %	99.77 %
65°	1.07	998.77	0.11 %	99.88 %
70°	0.66	999.43	0.07 %	99.94 %
75°	0.33	999.76	0.03 %	99.98 %
80°	0.13	999.89	0.01 %	99.99 %
85°	0.06	999.95	0.01 %	100.00 %
90°	0.05	1000.00	0.00 %	100.00 %
95°	0.00	1000.00	0.00 %	100.00 %
100°	0.00	1000.00	0.00 %	100.00 %
105°	0.00	1000.00	0.00 %	100.00 %
110°	0.00	1000.00	0.00 %	100.00 %
115°	0.00	1000.00	0.00 %	100.00 %
120°	0.00	1000.00	0.00 %	100.00 %
125°	0.00	1000.00	0.00 %	100.00 %
130°	0.00	1000.00	0.00 %	100.00 %
135°	0.00	1000.00	0.00 %	100.00 %
140°	0.00	1000.00	0.00 %	100.00 %
145°	0.00	1000.00	0.00 %	100.00 %
150°	0.00	1000.00	0.00 %	100.00 %
155°	0.00	1000.00	0.00 %	100.00 %
160°	0.00	1000.00	0.00 %	100.00 %
165°	0.00	1000.00	0.00 %	100.00 %
170°	0.00	1000.00	0.00 %	100.00 %
175°	0.00	1000.00	0.00 %	100.00 %
180°	0.00	1000.00	0.00 %	100.00 %

