

## HELLO Pendant

Designer: Josep Patsí

00-5275-CT-M1U v0



**Finish**  
Painted rust  
Opal  
NA

**Material**  
Polyurethane  
Steel  
Methacrylate

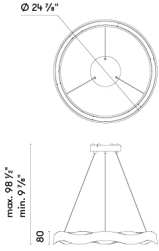
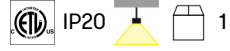

### TECHNICAL CHARACTERISTICS

#### Light source

Light source: LED  
Output (W): 23.8W  
Total power consumption (W): 28.3W  
Color temperature: LED warm-white  
2700K  
CRI: 80  
Real Lumen: 910  
Qty Leds: 288  
Lm/Real W: 32  
Life Time: 50.000h L80B20  
Bin / Grup: 27K  
UGR: 10.4

#### GEAR

Gear included: Yes, electronic  
Power Factor: 0.93  
Dimming protocol: 0-10V

#### Luminaire

Warranty: 5 Years

#### Logistics

EAN Code: 8435381456351  
Net Weight (Lb): 6.72  
Weight in Kg (packaged): 4.805  
Packing: - x - x -  
Masterbox: 1

The photograph may not match the reference exactly. Please read the product description to identify the finish.

**Luminaire**

Code 00-5275-CT-M1  
Name Colgante HELLO leds 24.3W

**Measur.**

Code 00-5275-CT-M1  
Name Colgante HELLO leds 24.3W

Luminaire Flux	910.10 lm	Luminaire Power	27.00 W	Efficacy	33.71 lm/W	Efficiency	100.00%
Lamps Flux	910.10 lm	Maximum value	516.82 cd	Position	C=0.00 G=0.00	CG	Double Symmetrical
Round Luminaire Round Luminous Area		Diam. Diam.	630 mm 610 mm	Height Height	83 mm 0 mm		
Horizontal Luminous Area Emitting area on Plane 0° Emitting area on Plane 90°		0.292247 m2 0.000000 m2 0.000000 m2		Emitting area on Plane 180° Emitting area on Plane 270° Glare area at 76°		0.000000 m2 0.000000 m2 0.070701 m2	
Coordinate system Date Measurement Distance		CG 20-04-2016 6.44		Symmetry Type Maximum Gamma Angle Measurement Flux		Double Symmetrical 90 910.10 lm	
Operator Temperature Humidity Notes		Asselum T2 24.00 °C 42.00 %		Source voltage Source current Photocell		230.00 V Prc	

Line	Code	Luminaire Lamps Name	Flux [lm]	Pow. [W]	Q.ty
- LEDS C4 LEDS	00-5275-CT-M1	Lámpara led 24.3W	910.10	27.00	1
C.I.E. F UTE	65 91 99 100 100 1.00 C	D DIN 5040 B NBN	A50 BZ 2 / 4 / BZ 3		

Diam=630mm

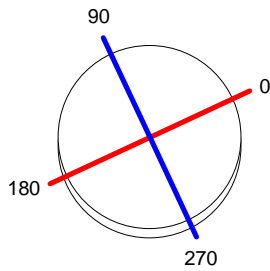

Semiplanos C

180.0 — 0.0  
270.0 — 90.0

ULOR 0.00 %  
DLOR 100.00 %  
RN 0.00 %

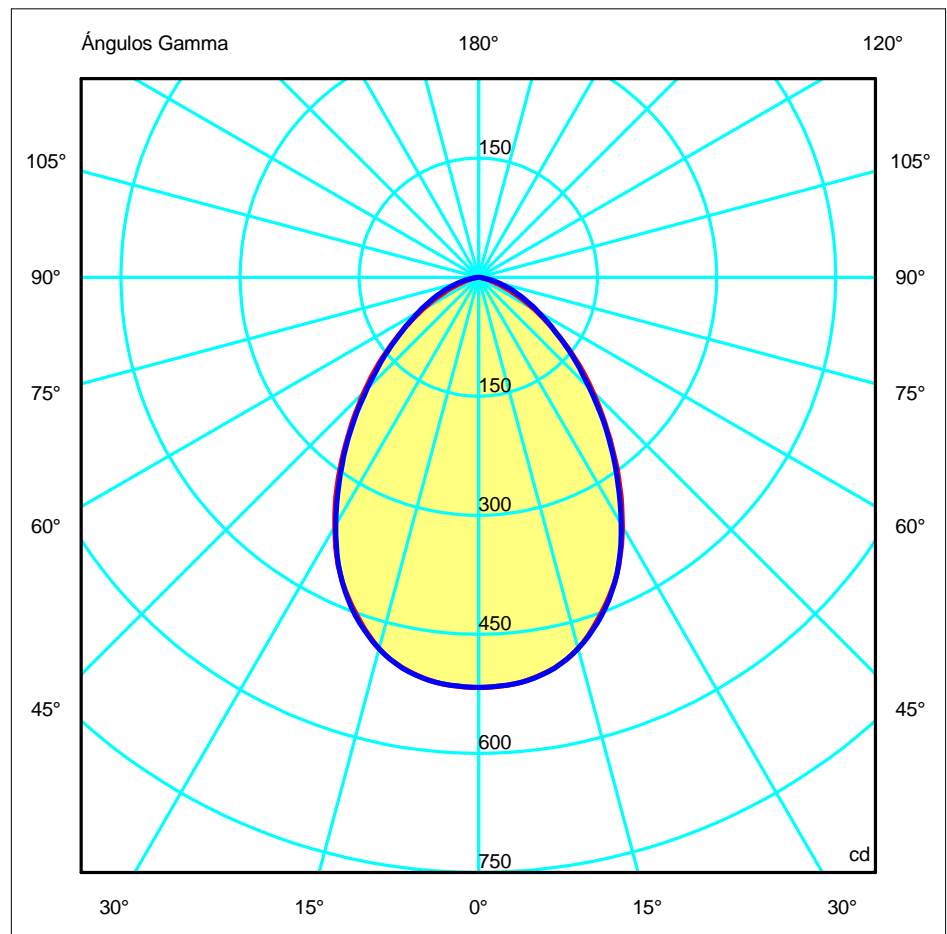

**Luminaire**

Code 00-5275-CT-M1  
Name Colgante HELLO leds 24.3W

**Measur.**

Code 00-5275-CT-M1  
Name Colgante HELLO leds 24.3W

Luminaire Flux	910.10 lm	Luminaire Power	27.00 W	Efficacy	33.71 lm/W	Efficiency	100.00%
Lamps Flux	910.10 lm	Maximum value	516.82 cd	Position	C=0.00 G=0.00	CG	Double Symmetrical

**Luminous Intensity Table cd Table 1/1**

	C 0.00	C 15.00	C 30.00	C 45.00	C 60.00	C 75.00	C 90.00
G 0.0	516.82	516.82	516.82	516.82	516.82	516.82	516.82
G 5.0	514.35	514.38	514.50	514.14	514.13	514.28	514.10
G 10.0	504.26	504.62	504.68	504.92	504.67	505.00	504.76
G 15.0	484.13	486.99	485.85	484.73	485.35	485.09	484.27
G 20.0	450.87	451.50	454.36	454.59	453.52	453.69	453.19
G 25.0	412.33	411.74	410.49	409.63	410.37	410.05	412.16
G 30.0	362.09	355.53	356.42	360.07	360.55	360.86	359.14
G 35.0	307.59	305.16	303.36	305.25	306.97	305.91	303.18
G 40.0	252.66	250.46	247.72	249.92	253.12	251.52	249.78
G 45.0	203.30	199.92	197.02	199.46	203.00	201.14	198.04
G 50.0	158.13	158.37	154.58	155.08	158.27	155.92	154.42
G 55.0	116.77	116.13	115.61	117.62	118.23	119.06	116.56
G 60.0	82.02	85.01	85.47	83.60	82.94	85.16	87.02
G 65.0	52.55	54.84	59.73	57.39	53.48	57.58	62.47
G 70.0	29.96	35.54	40.26	35.38	31.70	36.15	42.08
G 75.0	15.07	19.13	23.31	20.42	16.33	20.77	25.30
G 80.0	5.93	9.42	11.56	9.51	6.68	9.80	12.05
G 85.0	2.25	3.55	4.31	3.44	2.42	3.39	4.06
G 90.0	1.07	1.24	1.38	1.28	1.20	1.19	1.16

**Luminaire**

Code 00-5275-CT-M1  
 Name Colgante HELLO leds 24.3W

**Measurement**

Code 00-5275-CT-M1  
 Name Colgante HELLO leds 24.3W

Luminaire Flux	910.10 lm	Luminaire Power	27.00 W	Efficacy	33.71 lm/W	Efficiency	100.00%
Lamps Flux	910.10 lm	Maximum value	516.82 cd	Position	C=0.00 G=0.00	CG	Double Symmetrical

Diam=630mm

Semiplanos C

180.0 ——— 0.0  
 270.0 ——— 90.0

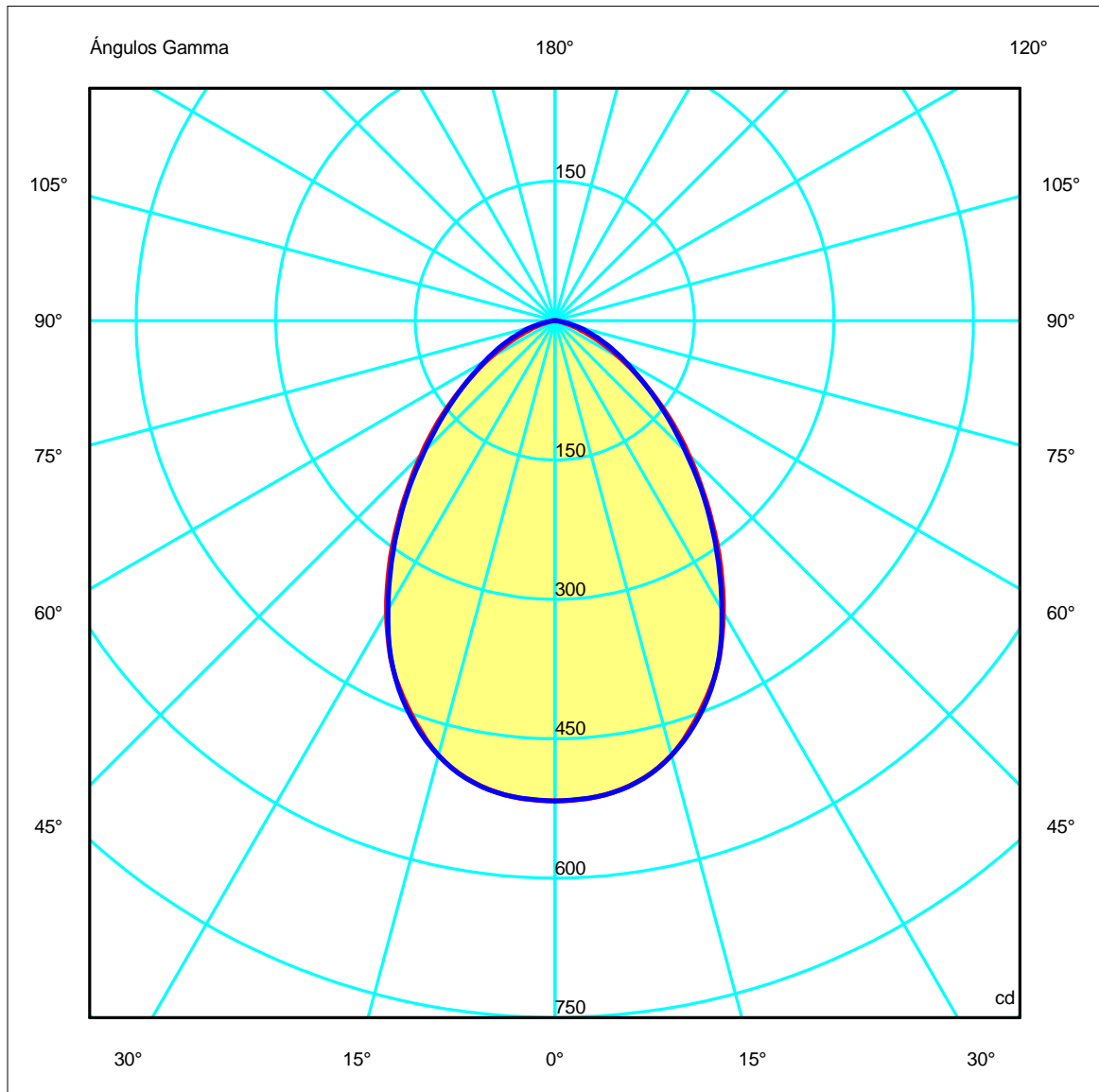
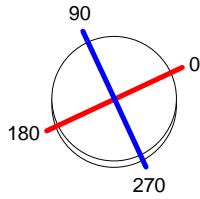

**Luminaire**

Code 00-5275-CT-M1  
 Name Colgante HELLO leds 24.3W

**Measur.**

Code 00-5275-CT-M1  
 Name Colgante HELLO leds 24.3W

Luminaire Flux	910.10 lm	Luminaire Power	27.00 W	Efficacy	33.71 lm/W	Efficiency	100.00%
Lamps Flux	910.10 lm	Maximum value	516.82 cd	Position	C=0.00 G=0.00	CG	Double Symmetrical

Diam=630mm

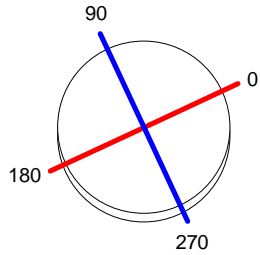

Semiplanos C

180.0 ———— 0.0  
 270.0 ———— 90.0

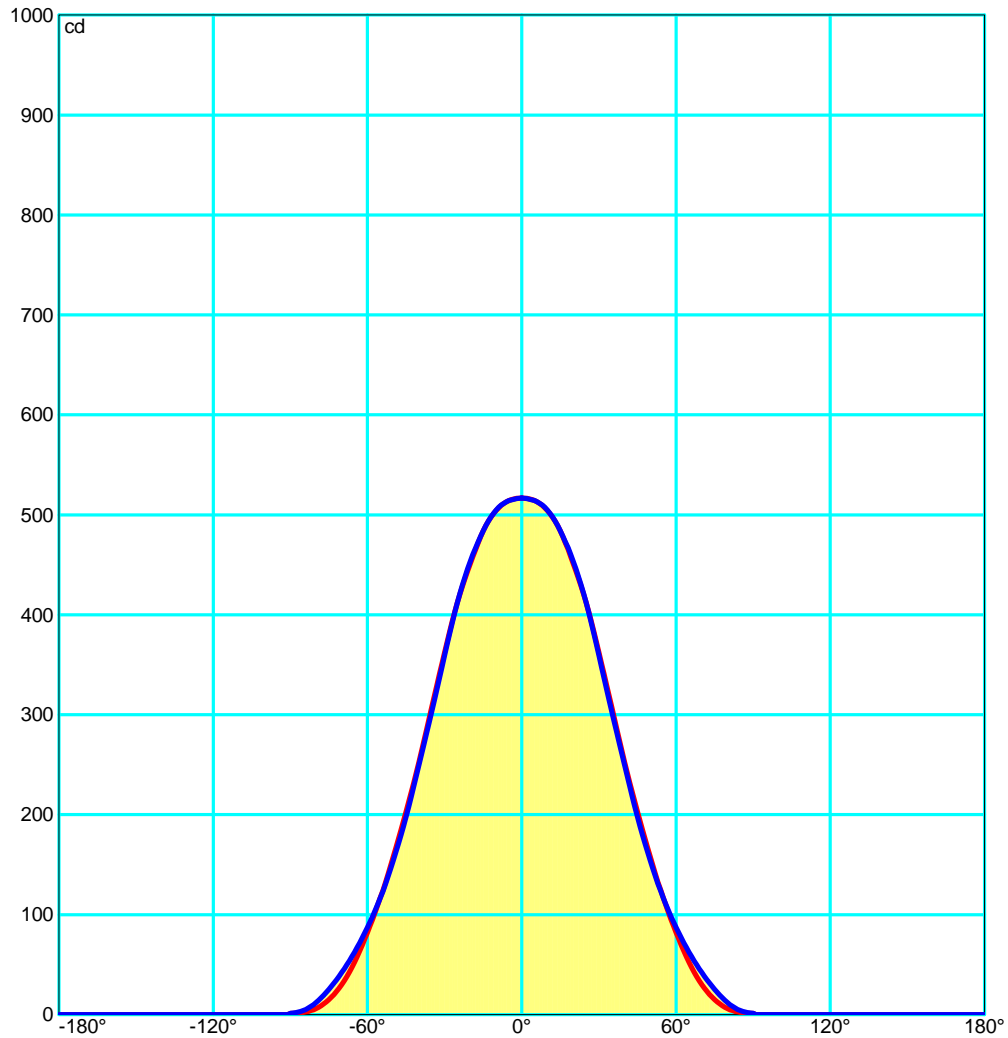

**Luminaire**

 Code 00-5275-CT-M1  
 Name Colgante HELLO leds 24.3W

**Measur.**

 Code 00-5275-CT-M1  
 Name Colgante HELLO leds 24.3W

Luminaire Flux	910.10 lm	Luminaire Power	27.00 W	Efficacy	33.71 lm/W	Efficiency	100.00%
Lamps Flux	910.10 lm	Maximum value	516.82 cd	Position	C=0.00 G=0.00	CG	Double Symmetrical

Flujo Total=910.10 Flujo Luminaria=910.10

RI	0.60	0.80	1.00	1.25	1.50	2.00	2.50	3.00	4.00	5.00	10.00	20.00
DRR	0.44	0.52	0.59	0.66	0.71	0.78	0.83	0.86	0.89	0.91	0.96	0.98
RC	3	3	3	2	2	2	2	2	2	2	2	2

Flujo Zonal por 1000 Lúmenes

Y°	10	20	30	40	50	60	70	80	90	100	110	120	130	140	150	160	170	180
ZF(Y)	54	203	410	619	790	907	970	995	1000	1000	1000	1000	1000	1000	1000	1000	1000	1000

 Códigos de Flujo C.I.E.  
 65 91 99 100 100

C.I.E.	3/3/3/2/2/2/2/2/2/2
D DIN 5040	A50
F UTE	1.00 C
B NBN	BZ 2 / 4 / BZ 3
RN	0.00000 %
BLF	1.0

LOR	99.99978 %
ULOR	0.00000 %
DLOR	99.99978 %
UFF	0.00000 %
DFF	100.00000 %
FFR	0.00000 %

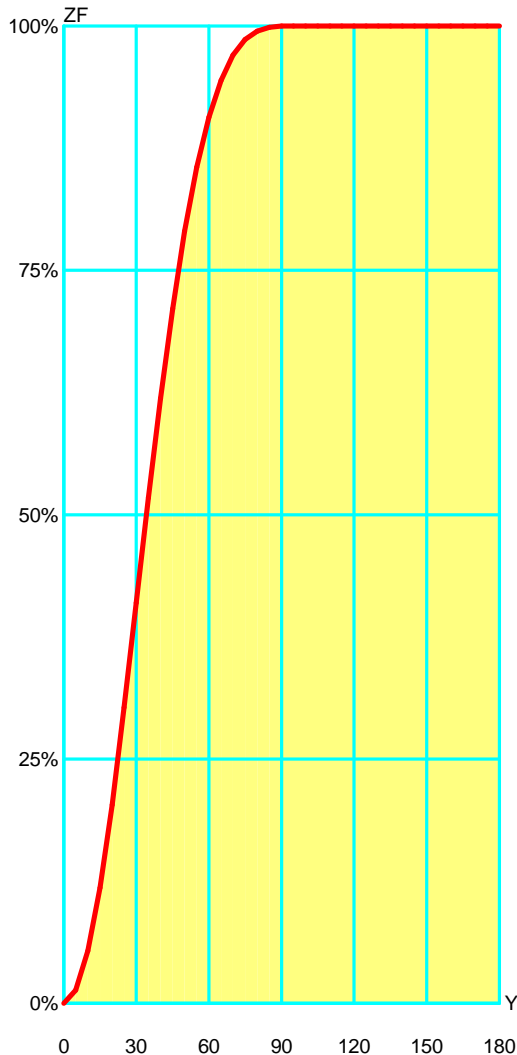

Gamma °	Flujo Zonal			
	Flujo	Suma lm	Flujo [%]	Suma [%]
0°	0.00	0.00	0.00%	0.00 %
5°	13.54	13.54	1.35 %	1.35 %
10°	40.05	53.60	4.01 %	5.36 %
15°	64.53	118.13	6.45 %	11.81 %
20°	85.00	203.13	8.50 %	20.31 %
25°	99.57	302.70	9.96 %	30.27 %
30°	107.04	409.74	10.70 %	40.97 %
35°	107.49	517.23	10.75 %	51.72 %
40°	101.93	619.16	10.19 %	61.92 %
45°	91.73	710.89	9.17 %	71.09 %
50°	79.18	790.07	7.92 %	79.01 %
55°	65.37	855.44	6.54 %	85.54 %
60°	51.22	906.66	5.12 %	90.67 %
65°	37.72	944.38	3.77 %	94.44 %
70°	25.76	970.14	2.58 %	97.01 %
75°	16.05	986.19	1.60 %	98.62 %
80°	8.63	994.82	0.86 %	99.48 %
85°	3.79	998.61	0.38 %	99.86 %
90°	1.39	1000.00	0.14 %	100.00 %
95°	0.00	1000.00	0.00 %	100.00 %
100°	0.00	1000.00	0.00 %	100.00 %
105°	0.00	1000.00	0.00 %	100.00 %
110°	0.00	1000.00	0.00 %	100.00 %
115°	0.00	1000.00	0.00 %	100.00 %
120°	0.00	1000.00	0.00 %	100.00 %
125°	0.00	1000.00	0.00 %	100.00 %
130°	0.00	1000.00	0.00 %	100.00 %
135°	0.00	1000.00	0.00 %	100.00 %
140°	0.00	1000.00	0.00 %	100.00 %
145°	0.00	1000.00	0.00 %	100.00 %
150°	0.00	1000.00	0.00 %	100.00 %
155°	0.00	1000.00	0.00 %	100.00 %
160°	0.00	1000.00	0.00 %	100.00 %
165°	0.00	1000.00	0.00 %	100.00 %
170°	0.00	1000.00	0.00 %	100.00 %
175°	0.00	1000.00	0.00 %	100.00 %
180°	0.00	1000.00	0.00 %	100.00 %

**Luminaire**

Code 00-5275-CT-M1  
Name Colgante HELLO leds 24.3W

**Measurement**

Code 00-5275-CT-M1  
Name Colgante HELLO leds 24.3W

Luminaire Flux	910.10 lm	Luminaire Power	27.00 W	Efficacy	33.71 lm/W	Efficiency	100.00%
Lamps Flux	910.10 lm	Maximum value	516.82 cd	Position	C=0.00 G=0.00	CG	Double Symmetrical

**UGR**  
S = 0.250

Reflectancies										
Ceiling/Cavity	0.7	0.7	0.5	0.5	0.3	0.7	0.7	0.5	0.5	0.3
Walls	0.5	0.3	0.5	0.3	0.3	0.5	0.3	0.5	0.3	0.3
WorkingPlane	0.2	0.2	0.2	0.2	0.2	0.2	0.2	0.2	0.2	0.2
RoomDimensions	ViewedCrosswise					ViewedEndwise				
x=2H y=2H	10.4	11.5	10.7	11.7	11.9	10.4	11.5	10.7	11.7	11.9
x=2H y=3H	10.9	11.9	11.2	12.2	12.6	11.1	12.1	11.4	12.3	12.6
x=2H y=4H	11.0	11.9	11.4	12.2	12.8	11.3	12.2	11.6	12.5	12.8
x=2H y=6H	11.1	11.9	11.4	12.2	12.9	11.4	12.3	11.8	12.6	12.9
x=2H y=8H	11.0	11.8	11.4	12.1	12.9	11.4	12.2	11.8	12.5	12.9
x=2H y=12H	11.0	11.8	11.4	12.1	12.8	11.4	12.2	11.8	12.5	12.8
x=4H y=2H	10.8	11.7	11.1	11.9	12.2	10.8	11.7	11.1	12.0	12.2
x=4H y=3H	11.5	12.3	11.9	12.6	12.9	11.5	12.3	11.9	12.6	12.9
x=4H y=4H	11.7	12.4	12.1	12.7	13.2	11.8	12.5	12.2	12.8	13.2
x=4H y=6H	11.8	12.4	12.2	12.7	13.3	12.0	12.5	12.4	12.9	13.3
x=4H y=8H	11.8	12.3	12.2	12.7	13.3	12.0	12.5	12.4	12.9	13.3
x=4H y=12H	11.8	12.2	12.2	12.7	13.3	12.0	12.5	12.4	12.9	13.3
x=8H y=4H	11.8	12.3	12.2	12.7	13.2	11.9	12.4	12.3	12.8	13.2
x=8H y=6H	11.9	12.4	12.4	12.8	13.3	12.0	12.5	12.5	12.9	13.3
x=8H y=8H	12.0	12.3	12.4	12.8	13.4	12.1	12.4	12.6	12.9	13.4
x=8H y=12H	12.0	12.3	12.5	12.8	13.4	12.1	12.4	12.6	12.9	13.4
x=12H y=4H	11.8	12.2	12.2	12.6	13.1	11.8	12.3	12.3	12.7	13.1
x=12H y=6H	11.9	12.3	12.4	12.7	13.3	12.0	12.4	12.5	12.8	13.3
x=12H y=8H	12.0	12.3	12.5	12.8	13.4	12.1	12.4	12.6	12.9	13.4

**Luminaire**

 Code 00-5275-CT-M1  
 Name Colgante HELLO leds 24.3W

**Measurerm.**

 Code 00-5275-CT-M1  
 Name Colgante HELLO leds 24.3W

Luminaire Flux	910.10 lm	Luminaire Power	27.00 W	Efficacy	33.71 lm/W	Efficiency	100.00%
Lamps Flux	910.10 lm	Maximum value	516.82 cd	Position	C=0.00 G=0.00	CG	Double Symmetrical

## Utilizations CIE

Mounting	Direct	Normalization										Normalised										Suspension Ratid/3										Standard CIE Settings																																																																																																																																																																																																																																																																																							
Ceiling																																																																																																																																																																																																																																																																																																																							
K	8873	8773	8871	8771	7773	7771	7753	7553	7751	7551	7731	7331	7711	7111	5551	5531	5331	5511	5111	3331	3311	1111	0000	0.60	200	180	146	132	171	126	106	90	76	65	42	32	17	12	60	34	30	14	11	28	12	10	0	0.80	232	213	154	142	203	136	134	118	86	76	51	40	24	18	71	42	38	20	17	36	17	15	0	1.00	254	236	154	144	225	138	157	141	92	82	57	47	30	23	77	49	45	26	22	42	23	20	0	1.25	274	258	151	143	245	138	181	165	96	88	63	54	37	30	82	55	51	33	29	49	29	26	0	1.50	289	274	148	141	261	136	201	185	98	91	68	59	43	36	86	60	56	39	34	54	35	32	0	2.00	308	296	139	134	282	130	230	215	100	94	75	67	53	46	89	67	64	49	44	61	44	41	0	2.50	321	311	133	129	296	125	251	238	101	96	79	73	61	54	91	72	70	56	52	67	52	48	0	3.00	330	321	128	125	307	122	267	255	101	97	83	77	67	60	93	76	74	62	58	71	58	54	0	4.00	344	337	123	121	322	119	290	279	102	99	88	83	75	69	95	82	80	70	67	77	66	63	0	5.00	353	347	121	119	332	117	305	296	103	101	91	87	80	75	97	86	84	76	73	81	72	69	0	10.00	373	370	115	114	355	112	339	334	105	104	99	96	92	89	101	95	94	89	87	91	86	83	0	20.00	383	382	112	111	367	110	358	356	106	106	103	102	100	98	103	100	99	97	96	97	94	91	0

## Wall

K	8873	8773	8871	8771	7773	7771	7753	7553	7751	7551	7731	7331	7711	7111	5551	5531	5331	5511	5111	3331	3311	1111	0000	0.60	410	399	342	335	393	331	309	302	267	262	224	220	193	191	260	220	219	191	190	218	190	190	169	0.80	454	442	364	358	434	353	353	344	294	289	252	248	221	218	285	248	246	219	218	244	218	217	192	1.00	479	468	371	365	457	359	381	371	307	302	268	263	238	235	297	263	261	235	234	259	233	232	204	1.25	501	490	374	369	476	363	407	396	317	312	281	276	253	249	306	275	273	250	247	270	247	245	214	1.50	516	505	374	370	490	364	426	415	323	318	290	285	264	259	312	283	281	260	257	278	256	254	220	2.00	525	516	361	358	498	351	443	433	319	315	293	288	270	265	308	285	283	265	262	278	260	257	219	2.50	529	521	350	347	501	341	454	444	314	311	292	287	272	267	303	283	281	266	263	276	261	256	216	3.00	529	521	339	337	500	330	459	449	308	305	288	284	271	267	296	279	278	264	262	272	258	253	211	4.00	537	531	333	331	507	325	474	465	307	305	292	288	277	273	295	282	280	269	267	273	262	256	211	5.00	544	539	331	329	514	323	485	478	308	306	295	292	283	279	296	285	284	274	272	276	267	260	213	10.00	560	557	326	325	529	319	512	507	311	310	303	301	296	293	299	292	291	286	284	282	276	268	217	20.00	558	556	313	312	526	306	517	514	302	301	298	296	294	292	289	286	285	282	281	275	272	262	209
---	------	------	------	------	------	------	------	------	------	------	------	------	------	------	------	------	------	------	------	------	------	------	------	------	-----	-----	-----	-----	-----	-----	-----	-----	-----	-----	-----	-----	-----	-----	-----	-----	-----	-----	-----	-----	-----	-----	-----	------	-----	-----	-----	-----	-----	-----	-----	-----	-----	-----	-----	-----	-----	-----	-----	-----	-----	-----	-----	-----	-----	-----	-----	------	-----	-----	-----	-----	-----	-----	-----	-----	-----	-----	-----	-----	-----	-----	-----	-----	-----	-----	-----	-----	-----	-----	-----	------	-----	-----	-----	-----	-----	-----	-----	-----	-----	-----	-----	-----	-----	-----	-----	-----	-----	-----	-----	-----	-----	-----	-----	------	-----	-----	-----	-----	-----	-----	-----	-----	-----	-----	-----	-----	-----	-----	-----	-----	-----	-----	-----	-----	-----	-----	-----	------	-----	-----	-----	-----	-----	-----	-----	-----	-----	-----	-----	-----	-----	-----	-----	-----	-----	-----	-----	-----	-----	-----	-----	------	-----	-----	-----	-----	-----	-----	-----	-----	-----	-----	-----	-----	-----	-----	-----	-----	-----	-----	-----	-----	-----	-----	-----	------	-----	-----	-----	-----	-----	-----	-----	-----	-----	-----	-----	-----	-----	-----	-----	-----	-----	-----	-----	-----	-----	-----	-----	------	-----	-----	-----	-----	-----	-----	-----	-----	-----	-----	-----	-----	-----	-----	-----	-----	-----	-----	-----	-----	-----	-----	-----	------	-----	-----	-----	-----	-----	-----	-----	-----	-----	-----	-----	-----	-----	-----	-----	-----	-----	-----	-----	-----	-----	-----	-----	-------	-----	-----	-----	-----	-----	-----	-----	-----	-----	-----	-----	-----	-----	-----	-----	-----	-----	-----	-----	-----	-----	-----	-----	-------	-----	-----	-----	-----	-----	-----	-----	-----	-----	-----	-----	-----	-----	-----	-----	-----	-----	-----	-----	-----	-----	-----	-----

## Working Pl.

K	8873	8773	8871	8771	7773	7771	7753	7553	7751	7551	7731	7331	7711	7111	5551	5531	5331	5511	5111	3331	3311	1111	0000	0.60	691	679	645	637	672	632	571	563	550	544	494	490	454	452	541	490	489	453	452	487	452	451	436	0.80	793	780	730	722	769	715	669	659	638	632	582	577	541	538	626	577	575	538	537	572	537	535	520	1.00	873	859	795	788	844	779	749	738	709	702	656	650	615	611	695	648	646	611	609	643	609	607	592	1.25	944	931	851	844	913	835	824	811	772	766	723	716	684	679	757	714	711	679	676	707	675	672	658	1.50	996	983	890	884	962	874	880	866	817	811	772	765	735	729	801	762	759	729	726	753	724	720	707	2.00	1000	1000	944	940	1000	929	964	951	884	878	846	839	814	808	866	834	831	806	802	823	799	793	781	2.50	1000	1000	976	973	1000	962	1000	1000	924	920	893	886	865	858	906	878	876	855	851	867	846	838	827	3.00	1000	1000	998	995	1000	984	1000	1000	952	948	925	918	901	893	933	910	907	889	885	897	879	870	859	4.00	1000	1000	1000	1000	1000	1000	1000	1000	983	980	961	955	941	935	963	945	942	928	924	930	916	905	894	5.00	1000	1000	1000	1000	1000	1000	1000	1000	1000	1000	998	983	978	966	960	981	965	963	951	947	949	937	925	915	10.00	1000	1000	1000	1000	1000	1000	1000	1000	1000	1000	1000	1000	1000	1000	1000	1000	1000	1000	1000	997	989	982	967	957	20.00	1000	1000	1000	1000	1000	1000	1000	1000	1000	1000	1000	1000	1000	1000	1000	1000	1000	1000	1000	1000	1000	1000	989	979
---	------	------	------	------	------	------	------	------	------	------	------	------	------	------	------	------	------	------	------	------	------	------	------	------	-----	-----	-----	-----	-----	-----	-----	-----	-----	-----	-----	-----	-----	-----	-----	-----	-----	-----	-----	-----	-----	-----	-----	------	-----	-----	-----	-----	-----	-----	-----	-----	-----	-----	-----	-----	-----	-----	-----	-----	-----	-----	-----	-----	-----	-----	-----	------	-----	-----	-----	-----	-----	-----	-----	-----	-----	-----	-----	-----	-----	-----	-----	-----	-----	-----	-----	-----	-----	-----	-----	------	-----	-----	-----	-----	-----	-----	-----	-----	-----	-----	-----	-----	-----	-----	-----	-----	-----	-----	-----	-----	-----	-----	-----	------	-----	-----	-----	-----	-----	-----	-----	-----	-----	-----	-----	-----	-----	-----	-----	-----	-----	-----	-----	-----	-----	-----	-----	------	------	------	-----	-----	------	-----	-----	-----	-----	-----	-----	-----	-----	-----	-----	-----	-----	-----	-----	-----	-----	-----	-----	------	------	------	-----	-----	------	-----	------	------	-----	-----	-----	-----	-----	-----	-----	-----	-----	-----	-----	-----	-----	-----	-----	------	------	------	-----	-----	------	-----	------	------	-----	-----	-----	-----	-----	-----	-----	-----	-----	-----	-----	-----	-----	-----	-----	------	------	------	------	------	------	------	------	------	-----	-----	-----	-----	-----	-----	-----	-----	-----	-----	-----	-----	-----	-----	-----	------	------	------	------	------	------	------	------	------	------	------	-----	-----	-----	-----	-----	-----	-----	-----	-----	-----	-----	-----	-----	-----	-------	------	------	------	------	------	------	------	------	------	------	------	------	------	------	------	------	------	------	------	-----	-----	-----	-----	-----	-------	------	------	------	------	------	------	------	------	------	------	------	------	------	------	------	------	------	------	------	------	------	------	-----	-----

LM53 SHR C0-C180: 1.075 SHR C90-C270: 1.075 SHR Square: 1.126



**Luminaire**

 Code 00-5275-CT-M1  
 Name Colgante HELLO leds 24.3W

**Measur.**

 Code 00-5275-CT-M1  
 Name Colgante HELLO leds 24.3W

Luminaire Flux	910.10 lm	Luminaire Power	27.00 W	Efficacy	33.71 lm/W	Efficiency	100.00%
Lamps Flux	910.10 lm	Maximum value	516.82 cd	Position	C=0.00 G=0.00	CG	Double Symmetrical

## Width at 50.00 % of Max Intensity

H[m]	1.00	2.00	3.00	4.00	5.00	H[m]	1.00	2.00	3.00	4.00	5.00
OA	0.82	1.65	2.47	3.29	4.12	OC	0.82	1.63	2.45	3.26	4.08
OB	0.82	1.65	2.47	3.29	4.12	OD	0.82	1.63	2.45	3.26	4.08

## Luminous Intensities [ cd ]

	0	5	15	25	35	45	55	65	75	85
OA	516.82	514.35	484.13	412.33	307.59	203.30	116.77	52.55	15.07	2.25
OB	516.82	514.35	484.13	412.33	307.59	203.30	116.77	52.55	15.07	2.25
OC	516.82	514.10	484.27	412.16	303.18	198.04	116.56	62.47	25.30	4.06
OD	516.82	514.10	484.27	412.16	303.18	198.04	116.56	62.47	25.30	4.06

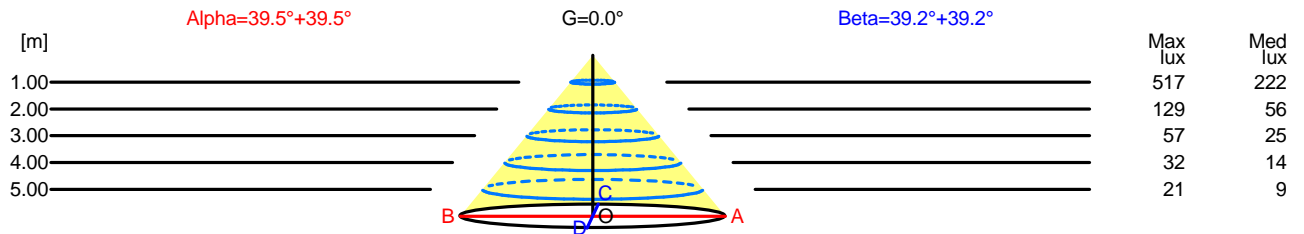

H[m]	D[m]	Max lux	Med lux	Alpha=39.5°+39.5°	G=0.0	
1.00	1.65	517	222			
2.00	3.29	129	56			
3.00	4.94	57	25			
4.00	6.59	32	14			
5.00	8.23	21	9			

H[m]	D[m]	Max lux	Med lux	Beta=39.2°+39.2°	G=0.0	
1.00	1.63	517	222			
2.00	3.26	129	56			
3.00	4.89	57	25			
4.00	6.52	32	14			
5.00	8.15	21	9			

**Luminaire**

Code 00-5275-CT-M1  
 Name Colgante HELLO leds 24.3W

**Measurment.**

Code 00-5275-CT-M1  
 Name Colgante HELLO leds 24.3W

Luminaire Flux	910.10 lm	Luminaire Power	27.00 W	Efficacy	33.71 lm/W	Efficiency	100.00%
Lamps Flux	910.10 lm	Maximum value	516.82 cd	Position	C=0.00 G=0.00	CG	Double Symmetrical

Isolux (Floor)

Luminaire position X=0.00m Y=0.00m Z=2.50m

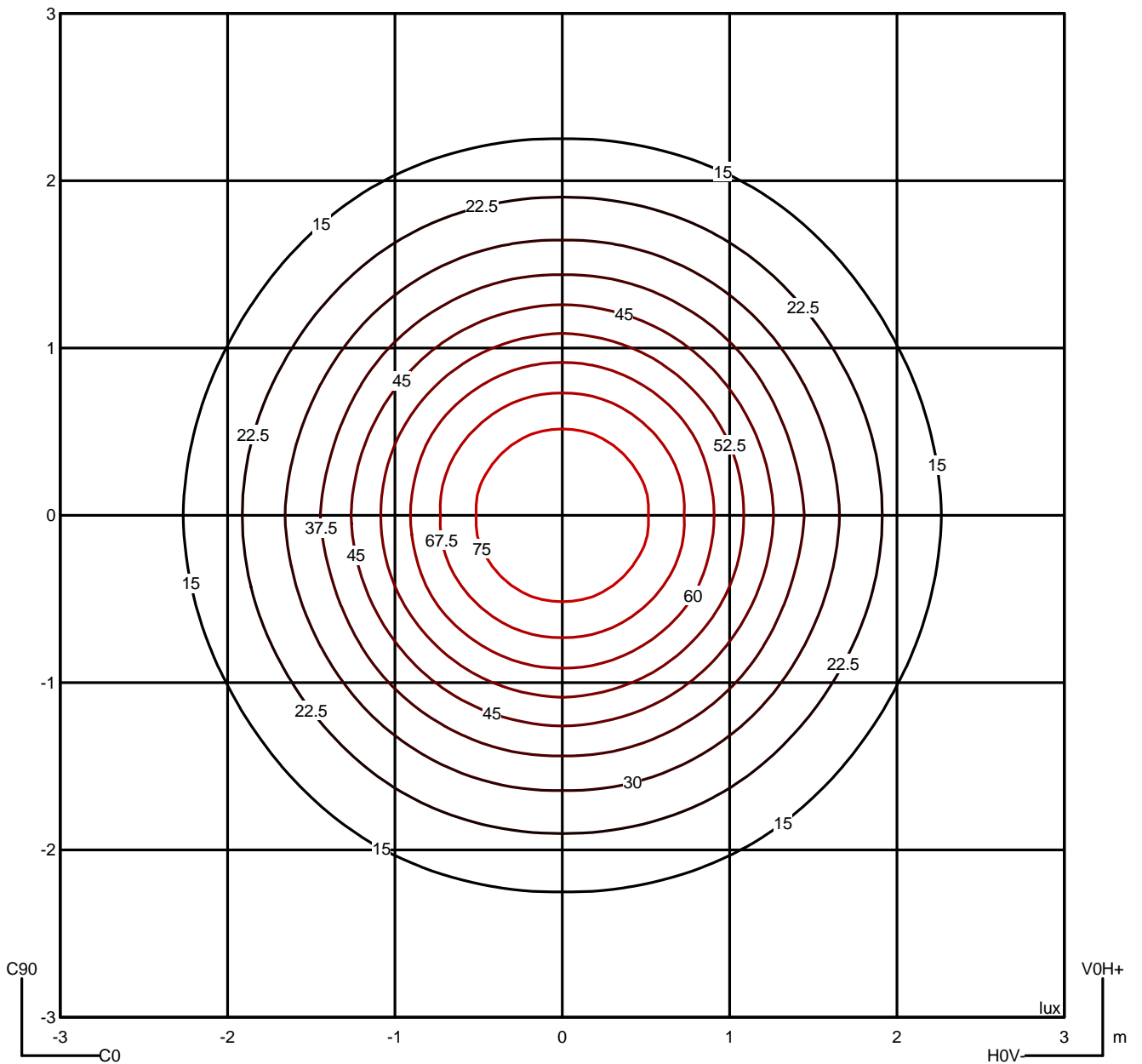

**Luminaire**

Code 00-5275-CT-M1  
Name Colgante HELLO leds 24.3W

**Measur.**

Code 00-5275-CT-M1  
Name Colgante HELLO leds 24.3W

Luminaire Flux	910.10 lm	Luminaire Power	27.00 W	Efficacy	33.71 lm/W	Efficiency	100.00%
Lamps Flux	910.10 lm	Maximum value	516.82 cd	Position	C=0.00 G=0.00	CG	Double Symmetrical

		Average Luminance [cd/m <sup>2</sup> ]									
		45°	50°	55°	60°	65°	70°	75°	80°	85°	
0.0°	984	842	697	561	425	300	199	117	88	---	
90.0°	958	822	695	596	506	421	335	238	160	---	

Flujo montado o vista longitudinal												
		Iluminancia (lx)										
A	A	2000	1000	750	500		<300				1.15	
B	1		2000	1500	1000	750	500	<300			1.5	
C					2000		1000	500	<300		1.85	
D	2						2000	1000	500	<300	2.2	
E	3							2000	1000	500	<300	2.55

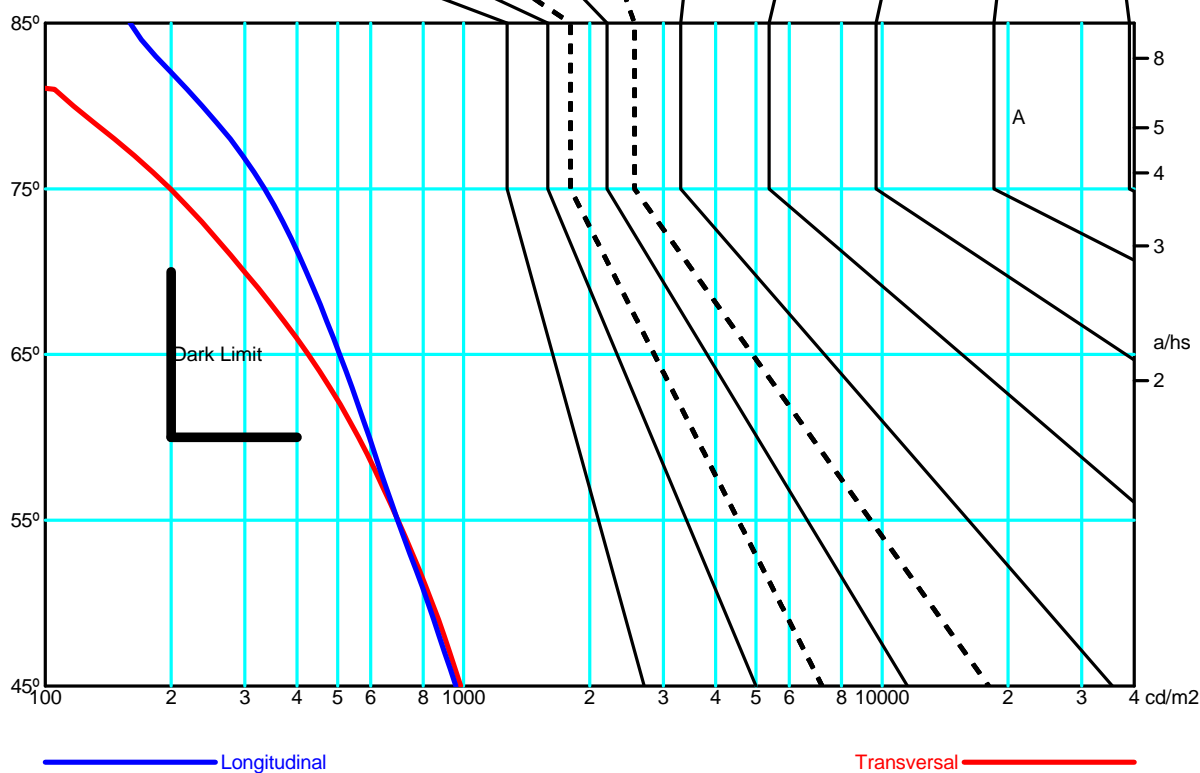

**Luminaire**

Code 00-5275-CT-M1  
 Name Colgante HELLO leds 24.3W

**Measur.**

Code 00-5275-CT-M1  
 Name Colgante HELLO leds 24.3W

Luminaire Flux	910.10 lm	Luminaire Power	27.00 W	Efficacy	33.71 lm/W	Efficiency	100.00%
Lamps Flux	910.10 lm	Maximum value	516.82 cd	Position	C=0.00 G=0.00	CG	Double Symmetrical

Luminance

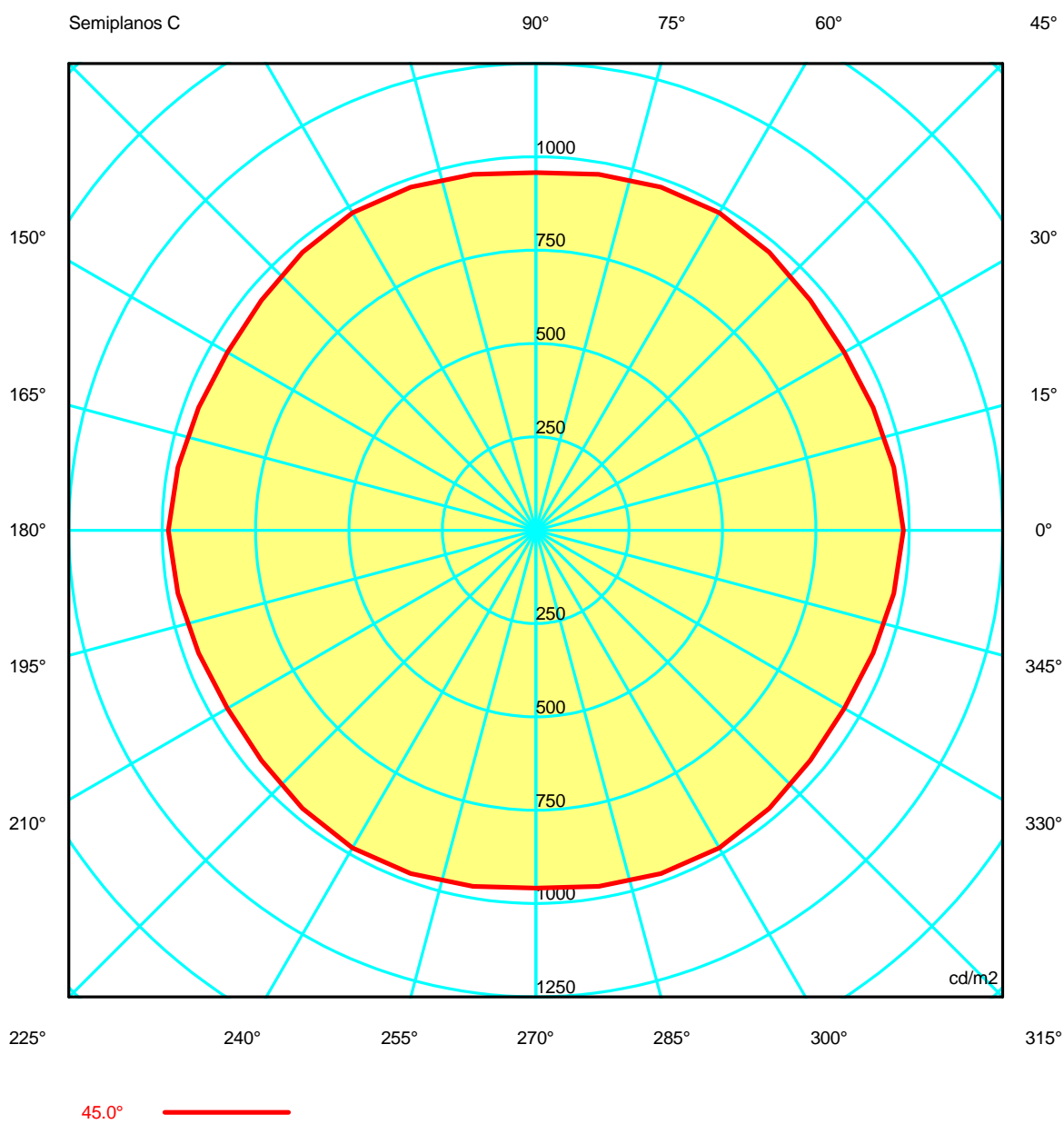

**Luminaire**

Code 00-5275-CT-M1  
Name Colgante HELLO leds 24.3W

**Measurerm.**

Code 00-5275-CT-M1  
Name Colgante HELLO leds 24.3W

Luminaire Flux	910.10 lm	Luminaire Power	27.00 W	Efficacy	33.71 lm/W	Efficiency	100.00%
Lamps Flux	910.10 lm	Maximum value	516.82 cd	Position	C=0.00 G=0.00	CG	Double Symmetrical

**Luminance cd/m2 Table 1/3**

	C 0.00	C 10.00	C 20.00	C 30.00	C 40.00	C 50.00	C 60.00	C 70.00	C 80.00	C 90.00	C 100.00	C 110.00	C 120.00
G 0.0	1768.45	1768.45	1768.45	1768.45	1768.45	1768.45	1768.45	1768.45	1768.45	1768.45	1768.45	1768.45	1768.45
G 5.0	1766.72	1766.79	1767.05	1767.24	1766.41	1765.79	1765.96	1766.37	1766.36	1765.85	1766.36	1766.37	1765.96
G 10.0	1752.07	1753.06	1753.42	1753.55	1754.25	1754.11	1753.51	1754.27	1754.63	1753.83	1754.63	1754.27	1753.51
G 15.0	1715.03	1723.15	1725.02	1721.10	1717.68	1717.59	1719.34	1719.14	1717.52	1715.50	1717.52	1719.14	1719.34
G 20.0	1641.77	1643.31	1647.39	1654.49	1656.21	1653.87	1651.43	1651.76	1651.83	1650.24	1651.83	1651.76	1651.43
G 25.0	1556.75	1555.49	1553.18	1549.82	1546.89	1547.40	1549.36	1548.15	1549.74	1556.10	1549.74	1548.15	1549.36
G 30.0	1430.67	1410.84	1402.76	1408.25	1418.76	1423.32	1424.56	1425.83	1424.40	1418.99	1424.40	1425.83	1424.56
G 35.0	1284.88	1278.25	1271.14	1267.20	1271.47	1278.45	1282.29	1280.47	1274.45	1266.43	1274.45	1280.47	1282.29
G 40.0	1128.58	1122.79	1113.73	1106.50	1110.93	1122.45	1130.63	1127.15	1120.40	1115.72	1120.40	1127.15	1130.63
G 45.0	983.80	973.25	961.25	953.42	958.84	972.41	982.32	978.32	968.26	958.32	968.26	978.32	982.32
G 50.0	841.78	845.21	837.03	822.90	821.17	832.35	842.51	835.67	826.08	822.01	826.08	835.67	842.51
G 55.0	696.60	694.45	690.66	689.70	697.69	703.57	705.31	709.89	707.38	695.34	707.38	709.89	705.31
G 60.0	561.27	576.23	585.17	584.95	576.82	568.51	567.59	576.94	587.73	595.55	587.73	576.94	567.59
G 65.0	425.47	434.41	458.55	483.62	477.08	450.15	432.98	450.90	480.46	505.80	480.46	450.90	432.98
G 70.0	299.71	335.34	377.48	402.76	376.26	334.17	317.14	341.52	381.90	420.95	381.90	341.52	317.14
G 75.0	199.21	232.74	275.97	308.13	291.86	244.82	215.89	248.52	297.44	334.53	297.44	248.52	215.89
G 80.0	116.81	163.54	205.84	227.72	209.22	161.59	131.59	167.16	212.72	237.52	212.72	167.16	131.59
G 85.0	88.30	122.95	154.37	169.39	152.17	116.24	94.87	116.80	145.06	159.58	145.06	116.80	94.87
G 90.0	0.00	0.00	0.00	0.00	0.00	0.00	0.00	0.00	0.00	0.00	0.00	0.00	0.00

**Luminaire**

Code 00-5275-CT-M1  
Name Colgante HELLO leds 24.3W

**Measurerm.**

Code 00-5275-CT-M1  
Name Colgante HELLO leds 24.3W

Luminaire Flux	910.10 lm	Luminaire Power	27.00 W	Efficacy	33.71 lm/W	Efficiency	100.00%
Lamps Flux	910.10 lm	Maximum value	516.82 cd	Position	C=0.00 G=0.00	CG	Double Symmetrical

**Luminance cd/m2 Table 2/3**

	C 130.00	C 140.00	C 150.00	C 160.00	C 170.00	C 180.00	C 190.00	C 200.00	C 210.00	C 220.00	C 230.00	C 240.00	C 250.00
G 0.0	1768.45	1768.45	1768.45	1768.45	1768.45	1768.45	1768.45	1768.45	1768.45	1768.45	1768.45	1768.45	1768.45
G 5.0	1765.79	1766.41	1767.24	1767.05	1766.79	1766.72	1766.79	1767.05	1767.24	1766.41	1765.79	1765.96	1766.37
G 10.0	1754.11	1754.25	1753.55	1753.42	1753.06	1752.07	1753.06	1753.42	1753.55	1754.25	1754.11	1753.51	1754.27
G 15.0	1717.59	1717.68	1721.10	1725.02	1723.15	1715.03	1723.15	1725.02	1721.10	1717.68	1717.59	1719.34	1719.14
G 20.0	1653.87	1656.21	1654.49	1647.39	1643.31	1641.77	1643.31	1647.39	1654.49	1656.21	1653.87	1651.43	1651.76
G 25.0	1547.40	1546.89	1549.82	1553.18	1555.49	1556.75	1555.49	1553.18	1549.82	1546.89	1547.40	1549.36	1548.15
G 30.0	1423.32	1418.76	1408.25	1402.76	1410.84	1430.67	1410.84	1402.76	1408.25	1418.76	1423.32	1424.56	1425.83
G 35.0	1278.45	1271.47	1267.20	1271.14	1278.25	1284.88	1278.25	1271.14	1267.20	1271.47	1278.45	1282.29	1280.47
G 40.0	1122.45	1110.93	1106.50	1113.73	1122.79	1128.58	1122.79	1113.73	1106.50	1110.93	1122.45	1130.63	1127.15
G 45.0	972.41	958.84	953.42	961.25	973.25	983.80	973.25	961.25	953.42	958.84	972.41	982.32	978.32
G 50.0	832.35	821.17	822.90	837.03	845.21	841.78	845.21	837.03	822.90	821.17	832.35	842.51	835.67
G 55.0	703.57	697.69	689.70	690.66	694.45	696.60	694.45	690.66	689.70	697.69	703.57	705.31	709.89
G 60.0	568.51	576.82	584.95	585.17	576.23	561.27	576.23	585.17	584.95	576.82	568.51	567.59	576.94
G 65.0	450.15	477.08	483.62	458.55	434.41	425.47	434.41	458.55	483.62	477.08	450.15	432.98	450.90
G 70.0	334.17	376.26	402.76	377.48	335.34	299.71	335.34	377.48	402.76	376.26	334.17	317.14	341.52
G 75.0	244.82	291.86	308.13	275.97	232.74	199.21	232.74	275.97	308.13	291.86	244.82	215.89	248.52
G 80.0	161.59	209.22	227.72	205.84	163.54	116.81	163.54	205.84	227.72	209.22	161.59	131.59	167.16
G 85.0	116.24	152.17	169.39	154.37	122.95	88.30	122.95	154.37	169.39	152.17	116.24	94.87	116.80
G 90.0	0.00	0.00	0.00	0.00	0.00	0.00	0.00	0.00	0.00	0.00	0.00	0.00	0.00

**Luminaire**

Code 00-5275-CT-M1  
Name Colgante HELLO leds 24.3W

**Measur.**

Code 00-5275-CT-M1  
Name Colgante HELLO leds 24.3W

Luminaire Flux	910.10 lm	Luminaire Power	27.00 W	Efficacy	33.71 lm/W	Efficiency	100.00%
Lamps Flux	910.10 lm	Maximum value	516.82 cd	Position	C=0.00 G=0.00	CG	Double Symmetrical

**Luminance cd/m2 Table 3/3**

	C 260.00	C 270.00	C 280.00	C 290.00	C 300.00	C 310.00	C 320.00	C 330.00	C 340.00	C 350.00
G 0.0	1768.45	1768.45	1768.45	1768.45	1768.45	1768.45	1768.45	1768.45	1768.45	1768.45
G 5.0	1766.36	1765.85	1766.36	1766.37	1765.96	1765.79	1766.41	1767.24	1767.05	1766.79
G 10.0	1754.63	1753.83	1754.63	1754.27	1753.51	1754.11	1754.25	1753.55	1753.42	1753.06
G 15.0	1717.52	1715.50	1717.52	1719.14	1719.34	1717.59	1717.68	1721.10	1725.02	1723.15
G 20.0	1651.83	1650.24	1651.83	1651.76	1651.43	1653.87	1656.21	1654.49	1647.39	1643.31
G 25.0	1549.74	1556.10	1549.74	1548.15	1549.36	1547.40	1546.89	1549.82	1553.18	1555.49
G 30.0	1424.40	1418.99	1424.40	1425.83	1424.56	1423.32	1418.76	1408.25	1402.76	1410.84
G 35.0	1274.45	1266.43	1274.45	1280.47	1282.29	1278.45	1271.47	1267.20	1271.14	1278.25
G 40.0	1120.40	1115.72	1120.40	1127.15	1130.63	1122.45	1110.93	1106.50	1113.73	1122.79
G 45.0	968.26	958.32	968.26	978.32	982.32	972.41	958.84	953.42	961.25	973.25
G 50.0	826.08	822.01	826.08	835.67	842.51	832.35	821.17	822.90	837.03	845.21
G 55.0	707.38	695.34	707.38	709.89	705.31	703.57	697.69	689.70	690.66	694.45
G 60.0	587.73	595.55	587.73	576.94	567.59	568.51	576.82	584.95	585.17	576.23
G 65.0	480.46	505.80	480.46	450.90	432.98	450.15	477.08	483.62	458.55	434.41
G 70.0	381.90	420.95	381.90	341.52	317.14	334.17	376.26	402.76	377.48	335.34
G 75.0	297.44	334.53	297.44	248.52	215.89	244.82	291.86	308.13	275.97	232.74
G 80.0	212.72	237.52	212.72	167.16	131.59	161.59	209.22	227.72	205.84	163.54
G 85.0	145.06	159.58	145.06	116.80	94.87	116.24	152.17	169.39	154.37	122.95
G 90.0	0.00	0.00	0.00	0.00	0.00	0.00	0.00	0.00	0.00	0.00

FIGURE N° 1. UNPACK THE FIXTURE: CHECK THE CONTENTS OF THE BOX. YOU SHOULD RECEIVE:

FIGURE N° 1. DÉBALLER LE PLAFONIER: VÉRIFIER LE CONTENU DU CARTON, VOUS DEVEZ RECEVOIR:

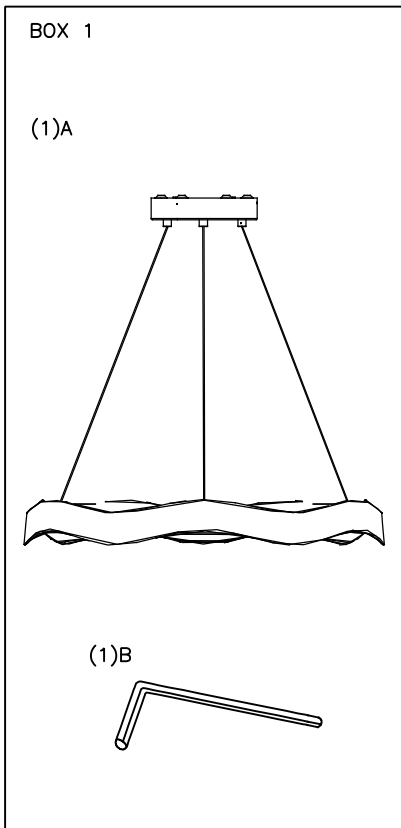

OUTLET BOX  
Boîte de distribution

FIGURE 6

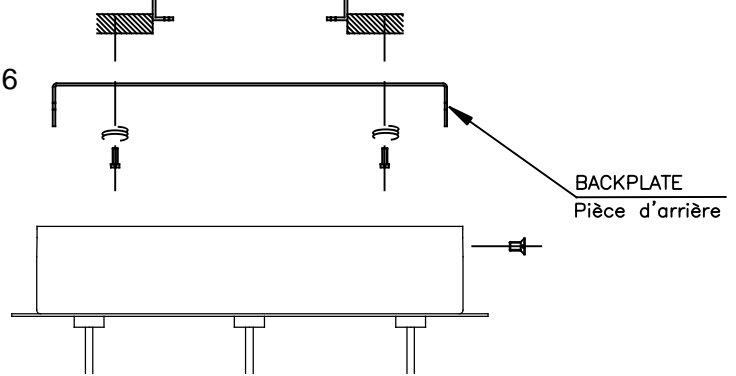
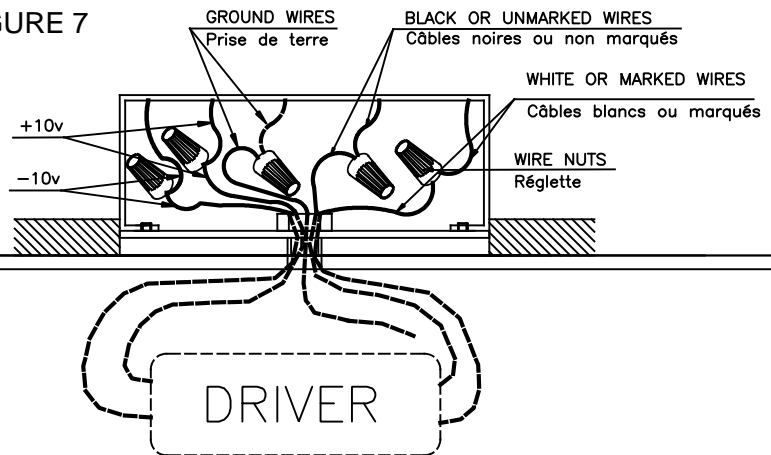

FIGURE 7



### INSTALLATION INSTRUCTIONS FOR HANGING FIXTURES

### INSTRUCTIONS D'INSTALLATION POUR PLAFONNIERS

FIGURE 3, 4 AND 5 MOUNTING HARDWARE.

NOTE: TEST THE CONNECTOR BY GENTLY PULLING IT. IF IT PULLS OUT THE CONNECTION, TRY AGAIN TILL YOU HAVE A FIRM CONNECTION. MAKE SURE NO BARE STRANDS OF WIRE STICK OUT FROM UNDER THE CONNECTORS.

FIGURE 3, 4 ET 5 MONTAGE DE L'ÉQUIPE.

IMPORTANT: ESSAYER DE TIRER LE CÂBLE D'ALIMENTATION DOUCEMENT. S'IL SORT DE LA CONNECTION, IL FAUDRAIT ASSURER QUE LA CONNECTION SOIT FERME. S'ASSURER QUE LES FILS DES CÂBLES NE SONT PAS À DÉCOUVERT DU CONNECTEUR.

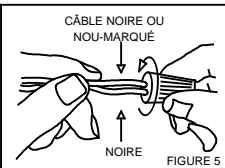
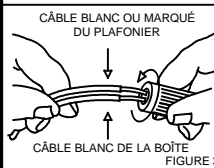
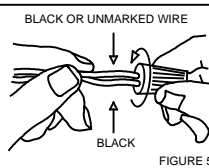
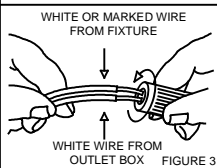

#### CAUTION:

"Warning", "This product is to be installed by a qualified electrician only."

"Suitable for dry locations only"

#### ATTENTION:

"Attention", le raccordement électrique sera effectué par un technicien électrique qualifié  
"Adéquat seulement en lieux secs."

#### CAUTION:

- 1.- Wrong lighting installation can be dangerous for your safety.
- 2.- Before starting, disconnect the power by turning off the general switch of the electric installation.
- 3.- Install light bulbs (not provided) that must not exceed markings on the fixture.
- 4.- To change the bulbs, disconnect the power by turning off the general switch and wait for the bulbs cool down.

#### INSTALLATION:

- 1.- Make electrical connections, carefully read the Electrical Connection section.
  - 2.- Assemble lighting onto the outlet box as shown on fig. 6, & 7.
- ELECTRICAL CONNECTIONS:** (See fig. 3, 4 y 5)
- 1.- Connect the white wire from the fixture to the white wire of the electric installation.
  - 2.- Connect the black wire from the fixture to the black wire of the electric installation.
  - 3.- Connect the grounding conductor from the fixture to the grounding wire of the electric installation.
  - 4.- Spread out the electrical wires so that the black ones are on one side of the outlet box and the white ones are on the other side, and carefully introduce them into the outlet box.

#### ATTENTION:

1. Une mauvaise installation peut compromettre votre sécurité.
2. Déconnecter la tension du réseau d'alimentation avant de réaliser toute opération.
3. Installer les ampoules (non fournies), ne pas utiliser d'ampoules d'un autre type ou d'une puissance supérieure à celle indiquée sur l'étiquette de la lampe.
4. Pour changer les ampoules, déconnecter la tension du réseau d'alimentation et laisser refroidir les ampoules.

#### INSTALLATION:

1. Connecter au réseau, lire attentivement la section de "Raccordements électriques"
  2. Installer l'appareil à la boîte de distribution comme indiqué dans les dessins 6 et 7.
- RACCORDEMENTS ÉLECTRIQUES (dessins 3, 4 et 5)**
1. Connecter le câble blanc de l'appareil au câble blanc de l'installation électrique.
  2. Connecter le câble noir de l'appareil au câble noir de l'installation électrique.
  3. Connecter le câble conducteur de prise de terre au câble de prise de terre de l'installation électrique.
  4. Distribuer les câbles pour que tout le câblage noir soit par dehors et le câblage blanc soit par dedans. Ajuster et immobiliser à la boîte sans coincer aucun câble.





LEDS-C4

LEDS, C4 S.A.  
CIF/VAT: A-59.410.910  
C/ Afueras s/n -TORA- 25750  
(LLEIDA) SPAIN  
TEL: 34 (73) 46 81 02  
FAX: 34 (73) 46 81 06

SHEET: 2/2  
EDITION: 01

REF: 00-5275U

8

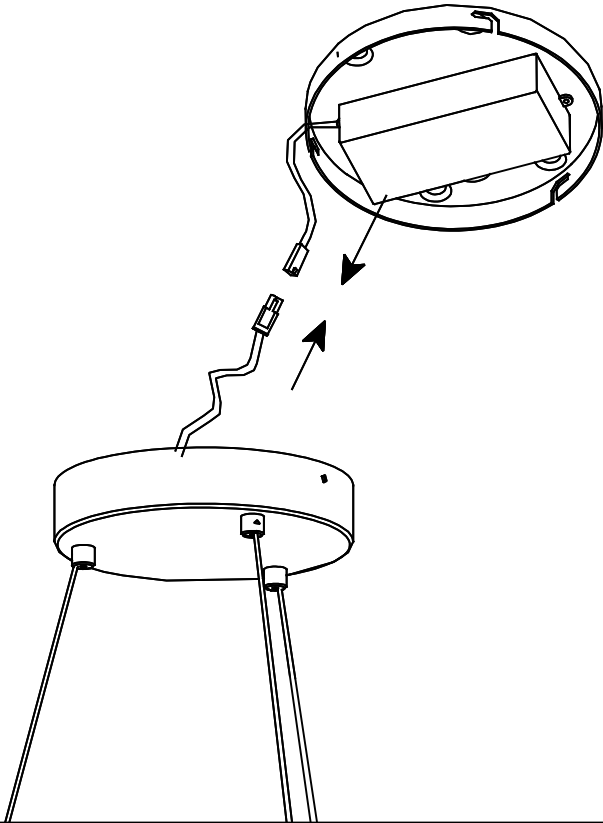

9

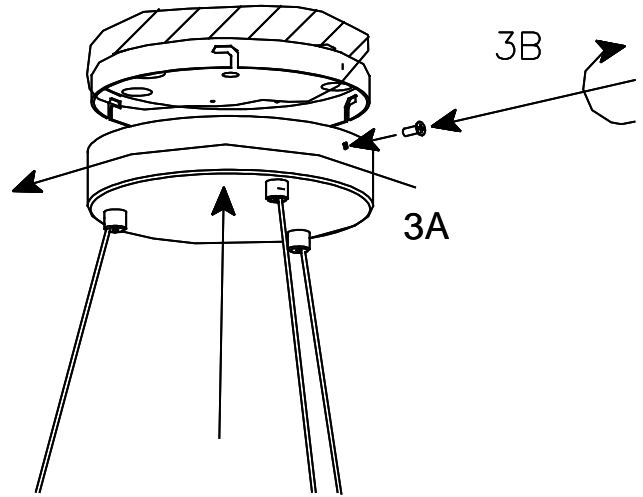

11

